

1-1-2013

Effect Of Folate Deficiency And Aging On Mtor Signaling Network In The Liver Of Dna Polymerase B Haploinsufficient Mice

Amanda Lynn Arrabi
Wayne State University,

Follow this and additional works at: http://digitalcommons.wayne.edu/oa_theses

 Part of the [Molecular Biology Commons](#), and the [Nutrition Commons](#)

Recommended Citation

Arrabi, Amanda Lynn, "Effect Of Folate Deficiency And Aging On Mtor Signaling Network In The Liver Of Dna Polymerase B Haploinsufficient Mice" (2013). *Wayne State University Theses*. Paper 258.

This Open Access Thesis is brought to you for free and open access by DigitalCommons@WayneState. It has been accepted for inclusion in Wayne State University Theses by an authorized administrator of DigitalCommons@WayneState.

**EFFECT OF FOLATE DEFICIENCY AND AGING ON mTOR SIGNALING
NETWORK IN THE LIVER OF DNA POLYMERASE β HAPLOINSUFFICIENT
MICE**

by

AMANDA ARRABI

THESIS

Submitted to the Graduate School

of Wayne State University,

Detroit, Michigan

in partial fulfillment of the requirements

for the degree of

MASTERS OF SCIENCE

2013

MAJOR: NUTRITION & FOOD SCIENCE

Approved By:

Advisor

Date

COPYRIGHT BY

AMANDA ARRABI

2013

All Rights Reserved

DEDICATION

I would like to dedicate this thesis to my loving and supportive family.

ACKNOWLEDGMENTS

I would like to sincerely thank my mentor Dr. Ahmad R. Heydari who has generously provided his time, energy, resources and support to the successful completion of this thesis. And special thanks go to Dr. Archana Unnikrishnan as I am extremely appreciative and grateful for all her valuable guidance, support, time, and effort that she has provided throughout the process. I would also like to thank my committee members, Dr. Kequan Zhou and Mary Width for reviewing my work. Finally, I would love to extend my gratitude to my lab members: Ali, Safa, Essra, Rawya, and Tom.

TABLE OF CONTENT

Dedication	ii
Acknowledgments	iii
List of Figures	vii
Chapter 1-Introduction	1
A. Folate	1
B. Folic Acid Food Fortification and Neural Tube Defects	2
C. Concerns about Potential Adverse Effects	3
1. Masking of B12 Deficiency Anemia	3
2. Cancer and Epigenetic Changes	3
D. Folate in One-Carbon Metabolism	4
E. Sources of DNA Damage	6
1. Hydrolytic Damage of DNA	6
2. Formation of Reactive Derivatives of Oxygen	7
F. Repair Mechanisms	8
1. Base Excision Repair	8

2. Nucleotide Excision Repair	10
G. DNA Polymerases	11
H. DNA Replication	12
I. Specific Roles of DNA β polymerase	13
J. β Polymerase and Repair Pathways Involving Gapped DNA	14
K. Over-expression of β Polymerase and its Effect on BER	15
L. Haploinsufficiency in β polymerase and its Effect on BER	16
M. Folate Deficiency, Aging, and Base Excision Repair	17
N. The mTOR Signaling Pathway	18
Chapter 2- Specific Aims	21
CHAPTER 3- Method	22
A. Animals	22
B. Diets and Carcinogenic Treatment	22
C. Aberrant Colonic Crypt (ACF) Analysis	23
D. Western Blot Analysis	23
E. Statistical Analysis	24

CHAPTER 4- Figures	26
CHAPTER 5- Results/ Discussion	53
CHAPTER 6- Conclusion	60
References	62
Abstract	67
Autobiographical Statement	69

LIST OF FIGURES

Figure 1-1: Folate and its Metabolism_____	5
Figure1-2: Base Excision Repair: The Short and Long Patch_____	9
Figure 1-3: The Mammalian Target of Rapamycin (mTOR) Signaling Pathway_____	20
Figure 4-1: Experimental design_____	25
Figure 4-2: The impact of β -pol ^{+/-} on the ACF formation in colon of mice treated with DMH_____	27
Figure 4-3: Effect of folate deficiency and DMH treatment on the protein levels of p-S6K in the young WT and β -pol ^{+/-} mice_____	29
Figure 4-4: Effect of folate deficiency and DMH treatment on the protein levels of p-4E-BP in the young WT and β -pol ^{+/-} mice_____	31
Figure 4-5: Effect of folate deficiency and DMH treatment on the protein levels of p-AKT in the young WT and β -pol ^{+/-} mice_____	33
Figure 4-6: Effect of folate deficiency and DMH treatment on the protein levels of p-AMPK in the young WT and β -pol ^{+/-} mice_____	35
Figure 4-7: Effect of folate deficiency and DMH treatment on the protein levels of IPMK in the young WT and β -pol ^{+/-} mice_____	37

Figure 4-8: Effect of folate deficiency and DMH treatment on the cleavage of PARP in the young WT and β -pol ^{+/-} mice_____	39
Figure 4-9: Effect of folate deficiency and DMH treatment on the protein levels of P53 in the young WT and β -pol ^{+/-} mice_____	41
Figure 4-10: Effect of folate deficiency and DMH treatment on the protein levels of p-4E-BP in the young and old β -pol ^{+/-} mice_____	43
Figure 4-11: Effect of folate deficiency and DMH treatment on the protein levels of p-AKT in the young and old β -pol ^{+/-} mice_____	45
Figure 4-12: Effect of folate deficiency and DMH treatment on the protein levels of IPMK in the young and old β -pol ^{+/-} mice_____	47
Figure 4-13: Effect of folate deficiency and DMH treatment on the cleavage of PARP in the young and old β -pol ^{+/-} mice_____	49
Figure 4-14: Effect of folate deficiency and DMH treatment on the protein levels of P53 in the young and old β -pol ^{+/-} mice_____	51

CHAPTER 1

INTRODUCTION

Nutrigenomics is becoming a rising field of study for nutritionists and molecular biologists to better understand the interaction of food and nutrients on the human genome. The main approach to such concerns is to closely observe how the diet modifies the gene expressions that control several cellular processes in the human body. Epidemiologic studies imply an inverse correlation between the intake of dietary folate and the risks of numerous melanomas including cancer of the liver, stomach, pancreas, colon, and the breast [1]. The exact impact of folate status on the development of these tumors in different body organs has not yet been well established [1]. However, a diet that is deficient in folate has shown to induce carcinogenesis by affecting the base excision repair homeostasis. Hence, it is important to understand the mechanism behind folate deficiency and the development of cancer.

A. Folate

Folate is an essential water-soluble vitamin that is involved in several mechanisms and pathways in relevance to the etiologies of birth defects and chronic diseases. Despite the fact that this vitamin is widely available in plant based food, it is often found to be under-consumed by individuals whose dietary habits emphasize on fast food and diets low in fruits and vegetables [2]. Folate is used as the generic term for the bioactive forms of the fundamental B vitamins

found in our diet [3]. These forms include the folate that is naturally available in food “pterolypolyglutamates”, and the folic acid that is used in vitamin supplements and fortified food products “monoglutamate folic acid” [3]. Folic acid has a crucial role in acting as a coenzyme in the metabolism of amino acids and nucleic acids. This vitamin is essential to maintain a normal cell division and is most important throughout early stages of development and growth [3]. This is the reason why the US and Canadian governments intervened more than a decade ago and applied obligatory folic acid fortification of most grains and cereal products to ensure adequate consumption of this vitamin.

B. Folic Acid Food Fortification and Neural Tube Defects

Neural tube defects (NTDs) are birth defects of the brain and/or the spinal cord that occur very early in embryonic development. This phenomenon occurs when the neural tube fails to close during the early stages of embryonic development which results in the destruction of the neural tissues [4]. Poor folate status is known to cause NTDs, miscarriages, and premature births. Therefore, women in a child bearing age are encouraged to consume a supplement containing 400 micrograms of folic acid daily. However, in the United States, almost more that 50% of all pregnancies are unplanned pregnancy which increases the chance of developing birth defects [4].

C. Concerns about Potential Adverse Effects

It is true that there are always serious concerns regarding potential adverse effects after implementing any intervention that targets the public health.

Some of these concerns are:

1. Masking of B₁₂ Deficiency Anemia

Certain concerns have been indicating that it is possible for folic acid to cause the masking of anemia related to vitamin B₁₂ deficiency. Previous studies have shown that consuming daily supplements high in folic acid (>5000 micrograms) could actually prevent the development of anemia that is caused by vitamin B₁₂ deficiency. This vitamin B₁₂ deficiency, if not detected at an early stage, could cause the progression of serious deficiency-related neuropathies [4].

2. Cancer and Epigenetic Changes

There has been a strong correlation between folate status and cancer development. Studies have shown that consuming a diet high in fruits and vegetables could possibly decrease the risks of developing many types of cancer. Based on this assumption, studies are being conducted to determine the mechanism behind the impact of folic acid on the changes in epigenetic patterns. Folate is being involved as a one-carbon methyl group donor in two basic metabolic pathways, the DNA synthesis and the DNA methylation [4]. This critical role suggests that folic acid could be preventing some cancers or could be

inducing other neoplasias. It has been believed that the adequate consumption of folic acid may prevent the development of tumor cells by providing enough methyl groups to enhance DNA repair when damage occurs. Whereas, some studies have shown that high consumption of folic acid actually advances the further development of pre-existing tumors. However, further studies should be conducted to better understand the effect of folic acid on epigenetics [4].

D. Folate in One-Carbon Metabolism

As discussed earlier, folate is an essential vitamin that is involved in multiple cellular functions such as cell division, DNA repair, and the regulation of the amino acid homocysteine [5]. It is important to understand how the folic acid status alters the one-carbon mechanism. 5-methylenetetrahydrofolate (5-methyl THF) is one of the main factors involved in the one-carbon metabolism. The enzyme methylenetetrahydrofolate reductase (MTHFR) is responsible for irreversibly converting 5,10-methylene THF into 5-methyl THF (figure 1-1). The most important functions that are involved in the folate metabolism are: the transfer of one carbon in the methionine cycle, the synthesis of thymidylate and purines (adenine and guanine), and the methylation reactions of the DNA. In the methionine cycle, 5-methyl THF is responsible for the remethylation of homocysteine to methionine. This produced methionine is then broken down to S-adenosylmethionine (SAM) which is considered a methyl group donor [5,6].

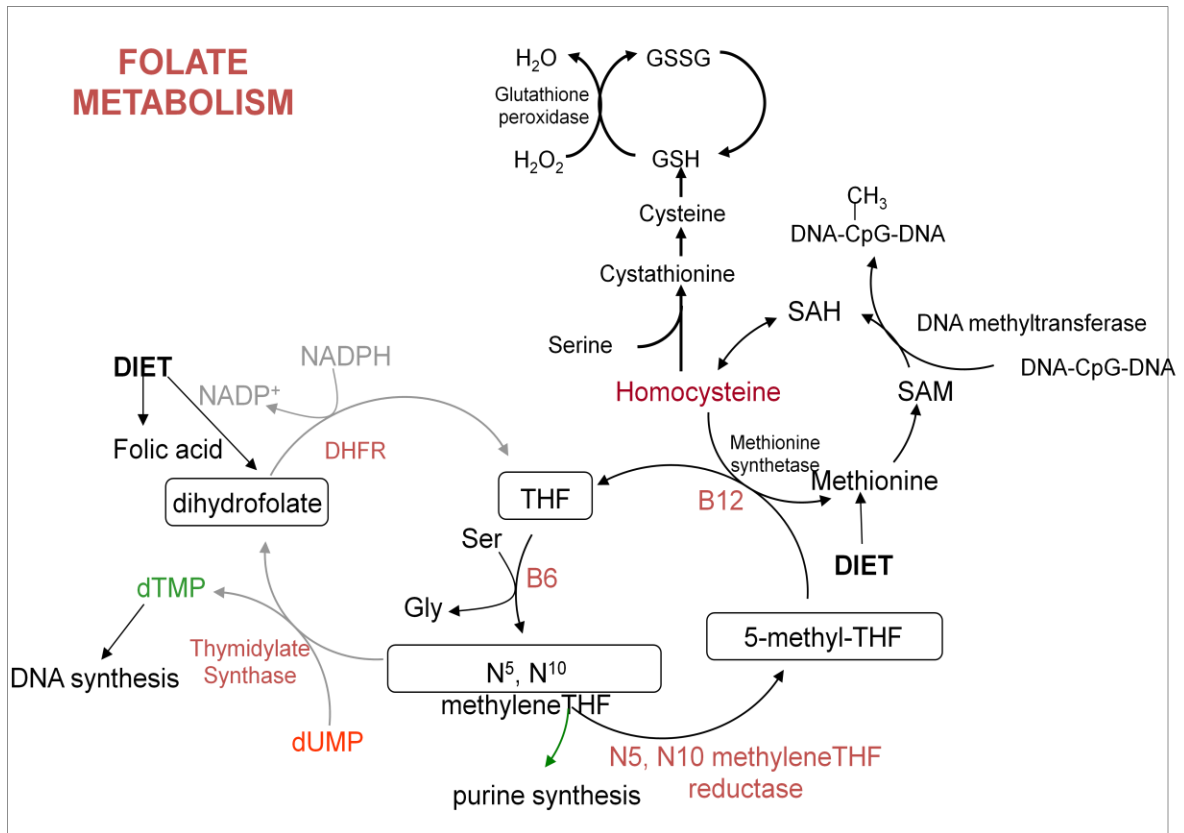

Figure 1-1:Folate and its Metabolism (2)

Moreover, since the 5-methyl THF is being used as the main methyl donor in the cycle, the levels of the adenine and the guanosine remain relatively sufficient [5]. Furthermore, thymidine is generated by the conversion of deoxyuridine monophosphate (dUMP) into thymidine monophosphate (TMP) during the pyrimidine biosynthesis pathway, with the help of the enzyme thymidylate synthase (TS) [5,6]. These reactions are required in order to be able to sustain proper DNA proliferation and repair when damage persists. However, this pathway is altered when folate is deficient, which can cause severe threats on the health of the population [5].

E. Sources of DNA Damage

Maintaining the integrity of the genomic material in the nucleus of the cells is a fundamental necessity for existence and survival. Failure to conserve the genetic information would result in cellular failure or in the constant inheritance of incorrect and mutated information. This has a massive effect mainly on the metabolism and the proliferation of the cell which in turn can cause cancer and tumors. It is interesting to assume that the reason behind the minimal mutation rates in the mammalian cells is the stability of inherited genome. But it is not actually the case. The DNA in the cell is being exposed to continuous insults from different sources which as a result alter its stability and integrity. Hence, the cell undergoes certain repair actions to eliminate the damage and conserve its information [7].

The human genetic material is highly susceptible to a vast variety of insults, including important spontaneous damages such as: hydrolytic decay of DNA, damage from oxidative stress as a result of cellular production of reactive oxygen species (ROS), defects from the metabolism of the nucleic acid which introduces errors during DNA replication, or even from environmental agents such as the exposure to UV light, toxic chemicals and radiation [7].

1. Hydrolytic Damage of DNA:

It is true that the DNA phosphodiester bonds are quite more stable than those of the RNA, but the removal of the hydroxyl group on the 2' sugar carbon in

the DNA destabilizes the N-glycosyl bond, which links the base with the sugar. Hence, the hydrolysis of the N-glycosyl bond leads to the actual loss of the bases. Moreover, the deamination of the bases of the DNA, such as the cytosine and 5- methylcytosine residues, is also another form of hydrolytic damage. Uracil is produced as a result of the deamination of cytosine which is later detected by the specific repair enzyme UDG and becomes repaired. Whereas, the normal DNA nucleotide, thymine, is produced as a result of the deamination of 5- methylcytosine, where G:U mispair sites are being repaired more efficiently than the G:T mispair sites. Hence, mutations occur more frequently with 5- methylcytosine residues [7].

2. Formation of Reactive Derivatives of Oxygen:

The unwanted elevated levels of reactive oxygen species (ROS) and the reduced production of antioxidants cause oxidative stress. Oxidants are elevated as a result of typical metabolic reactions such as: the mitochondrial electron transport, diverse oxygen-utilizing enzyme systems, and peroxisome function, which may be produced by phagocytic cells or formed from the peroxidation of lipids. The lipid peroxidation would damage the mitochondria that have cardiolipin, which activates cytochrome-c oxidase, in its inner membrane structure, whereas the protein oxidation affects the respiratory chain enzymes as well as ATPases [8]. The production of the ROS is also mainly due to the consumption of oxygen by the aerobic respiration for the oxidation of electron carriers. This

oxidation process converts oxygen (O_2) into superoxide anion (O_2^-) and produces H_2O as well, which is not quite reactive itself. But the availability of the OH hydroxyl group would undergo oxidation reaction with reduced transition metals such as Fe^{2+} [7]. These oxidative damages to DNA, RNA, proteins, and lipids will in turn damage the cell and cause cancer and early aging. Usually young cells have lower levels of ROS than older cells. These levels, if present at a very high rate would actually induce the cells to go to an earlier senescence [8]. Hence, any modification in the ROS equilibrium within a cell would prevent or restore cellular senescence. [9]

F. Repair Mechanisms

It is very important for such errors to be repaired immediately in order to prevent some irreversible changes or even the complete loss of the genetic material within the cell. The DNA response is a complex network of signaling pathways which is important for the protection of the genome. Upon detection of DNA damage, the cell has its own repair mechanisms that are involved in fixing the lesions. Some of these mechanisms are, base excision repair (BER), nucleotide excision repair (NER), and mismatch repair (MMR) [10].

1. Base Excision Repair

The specific pathway of the BER from bacterial cells to humans involves a number of coordinated steps. (1) Excision of a modified or altered base; (2)

cleavage of the generated AP site; (3) processing of the blocking termini at the break site; (4) repair synthesis; (5) ligation of the broken strands [11].

The first step in the BER pathway (figure 1-2) is catalyzed by DNA glycosylases that recognize the damaged or abnormal base in the DNA strand. Two types from the glycosylase enzymatic family are present with different catalytical mechanisms depending whether they have an associated AP lyase activity or not [11].

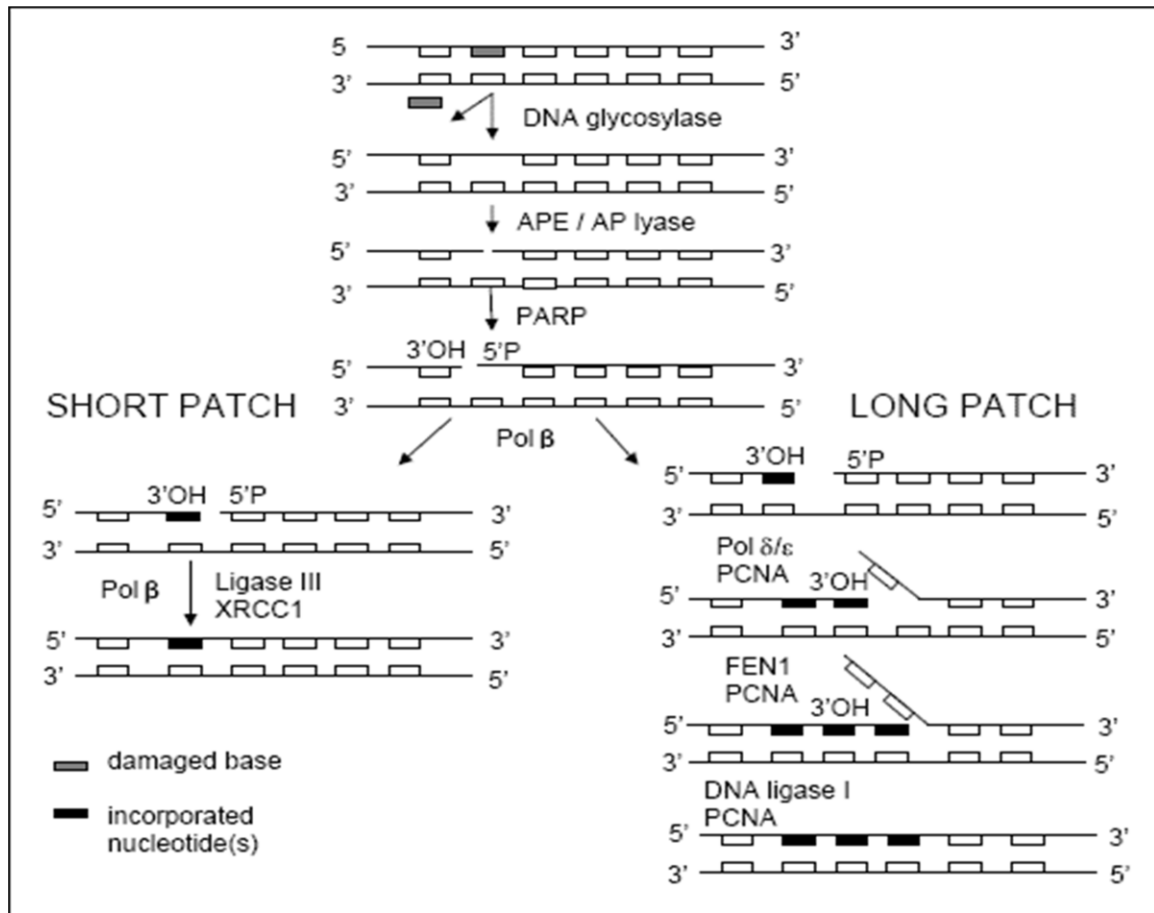

Figure 1-2: Base Excision Pathway: The Short and Long Patch (7)

Monofunctional DNA glycosylases actually hydrolyze the N-C1' glycosyl bond that is present between the specific base of interest and the sugar molecule which eventually leads to the generation of an AP site. Whereas the bifunctional DNA glycosylases excise the base of interest and then cleave the phosphodiester bonds 3' to an AP site by the action of AP lyase. This generates 3'-OH and 5' deoxyribose phosphate end of the strand break and leaves a single nucleotide gap. However, this gap is filled by a new specific nucleotide with the action of DNA polymerase and then sealed by the DNA ligase enzymes. Biochemical evidence has shown at least two important subpathways in this BER mechanism: the short-patch (one nucleotide) and the long-patch (more than one base). They both differ in the repair patch size as well as the enzymes involved in the process [11].

2. Nucleotide Excision Repair

The double stranded helix of the DNA is very important in the repairing process since such mechanism takes advantage of the other strand that carries the correct DNA sequence and aid in placing a complimentary base instead of the abnormal one that has to be excised. This NER repair mechanism is done via five steps. In step 1, the helicase enzyme is responsible for the unwinding of the double stranded DNA helix which forms a bubble site for the repair to take place. In step 2, an endonucleolytic activity is required for this step to form a first incision that takes place approximately six bases downstream of the lesion site. In step 3,

another endonuclease enzyme is required in this step to form a second incision that occurs approximately 22 bases upstream of the lesion site. By inserting these two incision sites to the damage-containing oligonucleotide, leaves it unlinked to the chromosomal DNA but still attached to the genome only through its base-pairing hydrogen bonds. In step 4, helicase enzyme removes the damage-containing oligonucleotide which results in forming a gap repair intermediate. Finally in step 5, the following gap is then all filled up by the DNA synthesis complex which uses the second normal strand of the DNA as the right template [11].

G. DNA Polymerases

In order to maintain life and survival, the genomic stability and consistency is a must throughout the cell replications. Prior to cell division in eukaryotic cells, the replication process of DNA must be able to conserve and accurately duplicate the whole entire bases with minimal to error-free procedure. [12] In fact, the DNA is never stable for it is frequently exposed to endogenous as well as exogenous factors that alter its stability. A while ago, scientists have predicted that eukaryotic genome is continuously encountering more than 100,000 modifications on a daily basis. To overcome such life threatening modifications, spontaneous repair mechanisms take place to conserve the DNA sequence as well as its structure [12]. DNA replication is performed by a complex of enzymes called DNA polymerases such as α , β and γ DNA polymerase [13]. In general,

the DNA polymerizing process is frequently coupled with a proof-reading $3' \rightarrow 5'$ exonuclease activity which directly eliminates any errors. In addition to that, the DNA polymerase family also plays important roles in the activity of the DNA primase and in the interaction with several proteins that are known to be implicated in the DNA replications, repair actions, cell cycle control as well in checkpoint functions [12]. Each one of the polymerases is more or less specific to a given process.

H. DNA Replication

DNA replication is a complex process that requires the incorporation of multiple specific enzymes and proteins to do the job. Some of these involved are DNA polymerases α , δ , and ϵ , DNA primase, topoisomerases I and II, the replication protein A (RPA), the replication factor C, the poly (ADP) ribose polymerase, as well as a DNA helicase and ligase. It is understood that β polymerase is responsible for the action of gap filling which links with the replication of the DNA [14]. At fork replication site, the fusion of the discontinuously formed Okazaki fragments forms the lagging strand of the DNA. Then, the RNases H confiscate the RNA primers that were still attached to the end side of the Okazaki fragments. Finally, the Ligase enzymes proceed with the ligation process and join the fragments together to complete the DNA synthesis [14].

I. Specific Roles of DNA β polymerase

In our lab we are more interested in the β polymerase as it contributes primarily in the DNA repair process. In normal scenarios, the β polymerase are normally expressed at stable but low levels all the way through the cell cycle and are usually influenced by many genotoxic treatments [14]. What actually discriminate β polymerase from all the rest are the following unique features: the absence of the linked proofreading action, the dishonesty in replicating DNA in vitro, as well as the inability to differentiate bases at the level of binding. However, the accuracy of the β polymerase is known to be increased upon the incorporation of a single nucleotide. A lot of recent studies show that excess expression of β polymerase would lead to the disturbance of the error-free mechanism theory which showed an increase in spontaneous mutagenesis and apoptosis due to the development of tumors in the cells [14].

J. β Polymerase and Repair Pathways Involving Gapped DNA

The three main types of DNA repair in the eukaryotic cells are BER, NER, and MMR. These repair processes actually produce nucleotide breaks and gaps that must be refilled again by the multiple actions of the DNA polymerases. The NER process eliminates the DNA lesions that are responsible for the DNA double helix deformations. Such pathway develops the damage by spotting these lesions, eliminating the part that is holding the modified nucleotides, and finally

synthesizing the right complementary nucleotides from the other strand using it as a template. Hence, the sensitivity and the precision of these DNA polymerases perfectly synthesize the DNA without any errors, which reveals the stability of the genes by inserting the correct complementary base in the right place [14]. The β polymerase plays an important role in the base excision repair pathway where the DNA damages as well as the DNA adducts are being corrected in this process [15]. β polymerase play important roles in both: the short patch and the long patch of the BER [16]. The actions of the polymerase and the lyase allow the β polymerase to be engaged in two main steps in the “short-patch” BER pathway. These steps are the removal of 5'-deoxyribose phosphate intermediate and then managing to fill the 1 nucleotide gap that had been produced [15]. β polymerase is also involved in the “long-patch” BER which fills the gaps of a number of nucleotides in a DNA [14]. It has been believed that the effectiveness of β polymerase is 800-10000 folds higher on 1- nucleotide DNA gap than on any other substrates. Hence, β polymerase are more consistent and precise in the short patch base excision repair [14]. In this pathway, the glycosidic bond that connects to the unwanted damaged nucleotide is being sliced up by the DNA glycosylase which in turn gets rid of the ruined base to produce an AP site in the DNA double strand [13]. Moreover, the phosphodiester backbone of the AP site is cut at the 5' end of the sugar by the action of the AP endonuclease enzyme. This in turn leaves behind a 3' -

hydroxyl group and a deoxyribose phosphate group at the 5' end. Consequently, the deoxyribose phosphate group is being removed and then catalyzed by the action of 2-deoxyribose-5-phosphate lyase which is very essential to the amino-end of the β polymerase. Finally, the β polymerase is responsible for filling up the gaps produced and then gets sealed up by the action of the ligase enzyme [13]. Hence, studies have shown that the action of the β polymerase is tightly linked to the action of the ligase [13].

K. Over-expression of β Polymerase and its Effect on BER

As mentioned earlier, genetic stability depends on the presence of low but constant levels of β polymerase in order to perform its optimal function [14]. Hence, elevated and advanced levels of β polymerase causes genetic instability, development of cancer, as well as tumor progression [17]. Recent observations have indicated that the over expression of β polymerase is involved in some tumor/cancerous cell lines such as leukemia and ovarian cancer cells [14]. Moreover, this over expression would lead to significant increase in β polymerase messenger RNA as well as its translated proteins in some tumor cell lines [18]. For instance, β polymerase was observed to be significantly 10-folds higher in breast, colon, and prostate cancer tissues than nearby normal cells [17]. Based on all of these findings, it has been hypothesized that the over expression of β polymerase as well as its mRNAs and proteins actually disturb

the entire DNA polymerase perfect error free task in some cancer cells; this will affect the β polymerase gap filling process during DNA repair, replication or recombination pathways and consequently cause mutations and cancer developments [17].

L. Haploinsufficiency in β polymerase and its Effect on BER

It is fascinating how the mouse model has become the most common and reliable model of choice to observe the different elements of mammalian development and physiology [19]. Despite the fact that mouse models are becoming cheaper and easier to apply on, it is actually the ability to genetically modify and change the mouse's genome is what makes it one of the most dominant resource available for science research. One way to study the effect of the DNA polymerase β on the base excision repair pathway is to genetically manipulate the gene encoding this DNA polymerase. For this purpose, transgenic mice have been generated with a heterozygous germline deletion mutation located in the 5' end of the DNA polymerase β gene. As these transgenic mice have been bred, the offspring that represents the homozygous β pol deletion mutation never survived beyond 10.5 days of gestation [20]. Data has shown that the DNA β -pol heterozygous (β -pol $^{+/-}$) mice established a ~50% reduction in the expression of β -pol mRNA and protein [21]. This finding supports the observation of a significant reduction in the BER mechanism which

is caused by heterozygous β -pol deletion [21,22]. Moreover, aging is also considered a main factor in exponentially increasing the risk of cancer [22]. It is believed that the accumulated DNA damage produced with the correlation of aging increases the risk of cancer development [22]. Interestingly, it is observed that only the mammalian β -pol has a significant and specific role in the base excision repair mechanism, which it is believed that it is impossible to be substituted by any of the α , β and γ DNA polymerases [20].

M. Folate Deficiency, Aging, and Base Excision Repair

In order to understand the mechanism behind the effect of folate deficiency on the development of cancer and tumors, it is important to consider the influence of this deficiency on the base excision repair pathway [6,34]. Normally, the BER pathway is established by the harmonization of sequenced enzymatic actions to repair the damage and eliminate any accumulations of intermediate products that may be produced during the process. Folate deficiency disturbs the equilibrium and the coordination of the BER by promoting the initiation of the process without any further stimulation for the completion of repair. This initiation increases the accumulation of strand breaks, uracil, and mutations which in turn inhibits the DNA repair process. This abnormal regulation of the repair pathway brings on a state of BER deficiency that is observed in β -pol^{+/-} mice [23,24]. A recent study has shown that a folate deficient diet have established a considerable increase in aberrant crypt foci (ACF) and tumor

development in wild type mice that had been previously exposed to a carcinogen [24]. On the contrary, a significant reduction in the ACF has been shown in β - pol haplinsufficient mice with folate deficiency [24]. Hence, folate deficiency is assumed to provide a protective approach against tumorigenesis in a BER-deficient medium in all tissues when treated with a carcinogen [24,25]. It has been believed that there is a tight correlation between folate deficiency, aging, and carcinogenesis which might be explained by the increased mutagenesis [25].

N. The mTOR Signaling Pathway

The mammalian target of rapamycin (mTOR) could be influenced by multiple factors including some alterations in nutrient transport, energy metabolism, protein availability, and purine biosynthesis. This signaling pathway is interrupted in diseases that disrupt further growth and cause nutrient imbalances such as cancer, inborn error diseases, aging, and metabolic disorders. Once the mTOR pathway is deregulated, the proliferation of cancer cells gets stimulated causing further damage [26]. On the other hand, the additional excitement of the following pathway resulting from the excess intake of nutrients might be increasing the risk of developing diabetes [26].

In certain tumors and cancer stages, the upstream and downstream signaling mechanisms of the substrates have a major effect on the mTOR pathway [27] (figure 1-3). In normal conditions, AKT controls the cell proliferation and endurance, as well as controlling nutrient metabolisms by the proliferation of

some proteins [28]. The substrates eIF4E binding protein (4EBP) and S6 Kinase 1 (S6K1), along with the correlation of mRNAs, help in normalizing the rate of protein synthesis by adjusting the initiation and elongation of the mRNA translation [26]. The protein 53 (p53), that is responsible in activating the DNA repair proteins when the DNA is being damaged, functions as an anti-cancer component [29]. Inositol polyphosphate multikinase (IPMK) has been classified as an mTOR cofactor and a significant component in stimulating the signaling pathway by responding to amino acid levels [30]. Adenosine Monophosphate - activated kinase (AMPK) has a powerful ability to sense any energy imbalances and react to any fluctuations in the AMP; ATP ratio [30]. Poly (ADP-ribose) polymerase (PARP) is an enzyme that plays an important role in responding to cellular death. This intervention could be involved in DNA transcription and repair, as well in the stability of the genome [31]. Hence, it is important to examine how the following substrates and proteins participate in the regulation of the mTOR signaling pathway in a folate deficient environment.

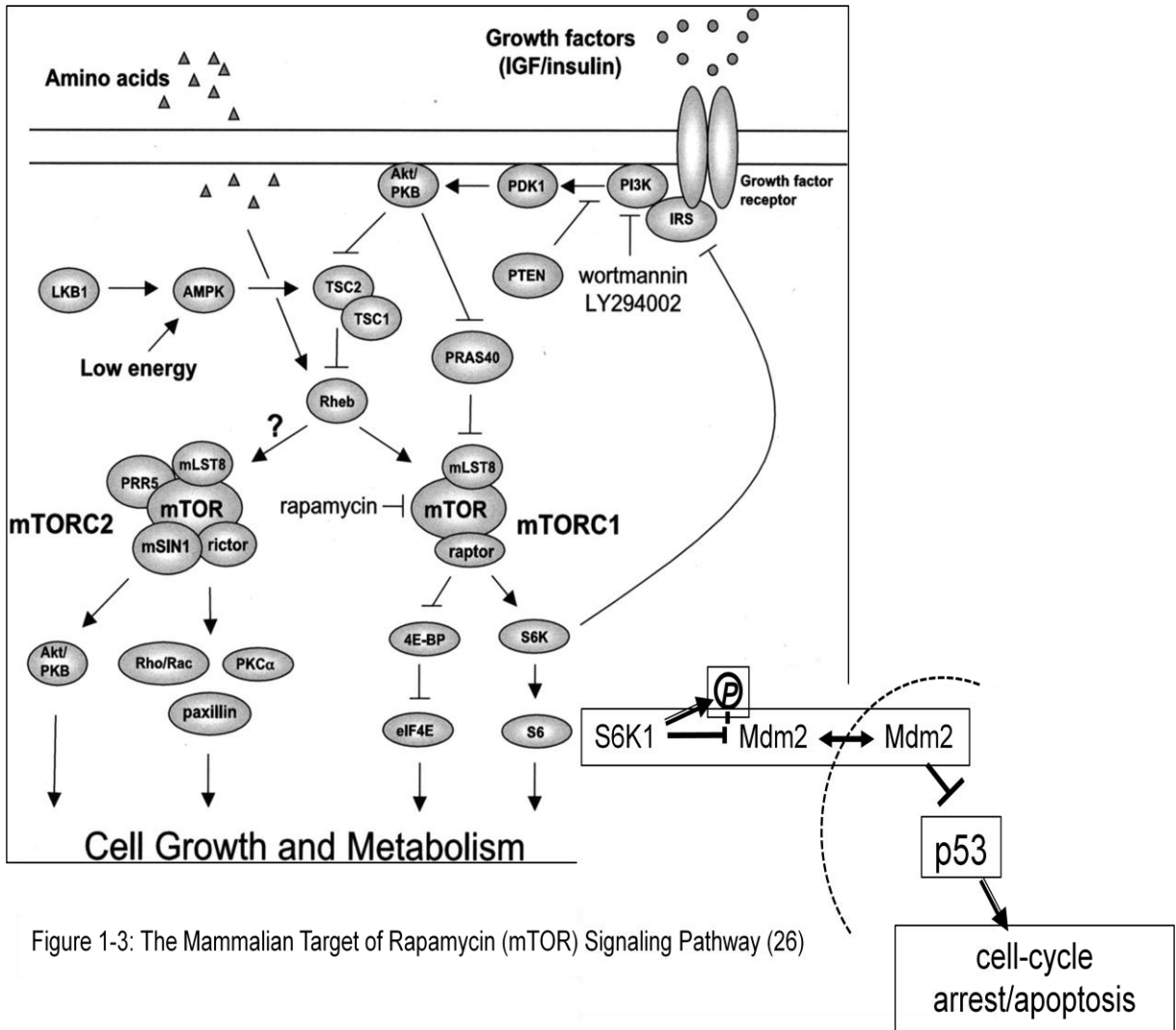

Figure 1-3: The Mammalian Target of Rapamycin (mTOR) Signaling Pathway (26)

CHAPTER 2

SPECIFIC AIMS

In order to understand the mechanism behind the effect of folate deficiency on the development of cancer and tumors, it is important to examine the influence of this deficiency on the base excision repair pathway and on the mTOR signaling pathway. Once the mTOR pathway is deregulated, the proliferation of cancer cells gets stimulated causing further damage. In certain tumors and cancer stages, the upstream and downstream signaling mechanisms of the substrates have a major effect on the mTOR pathway. We hypothesize that dietary folate restriction alters mTOR signaling network in the liver to provide protection against cancer in young and old β -pol^{+/-} mice that have been treated with a carcinogen.

The following are the specific aims of the research:

Specific Aim 1: To examine if folate deficiency provides a protective role in the β -pol^{+/-} young and old mice that have been treated with a colon and liver carcinogen by measuring the ACF counts per mouse.

Specific Aim 2: To examine the impact of folate deficiency on the signaling mechanisms of the substrates involved in the regulation of the mTOR signaling pathway in the β -pol^{+/-} young and old mice that have been treated with a colon and liver carcinogen.

CHAPTER 3

METHODS

A. Animals

Experiments were performed in young 4 to 6-month-old C57BL/6-specific pathogen-free male mice and mice heterozygous for the DNA polymerase β gene (β -*pol*^{+/-}). All practices performed on animals were in agreement with the National Institutes of Health guidelines for the care and use of laboratory animals. Mice heterozygous for the DNA polymerase β gene (β -*pol*^{+/-}) were created in Rajewsky's laboratory by deletion of the promoter and the first exon of the β -*pol* gene. Homozygous deletion of β -*pol* results in embryonic lethality, but the heterozygous mice survive and seem to be normal and are fertile; there is no retardation in food intake, weight gain, or growth rate. All mice were backcrossed into C57BL/6 for at least 20 generations. The genotype of the mice was determined by Southern blot analysis as described by Cabelof *et al.* The Wayne State University Animal Investigation Committee approved the animal protocol. Mice were maintained on a 12-h light/dark cycle and given water *ad libitum* [34].

B. Diets and Carcinogenic Treatment

After acclimation for 7 days, wild type (WT) and β -*pol*^{+/-} mice were randomly assigned to two dietary groups: a folate-adequate (FA) or folate-deficient (FD) AIN93G-purified isoenergetic diet (Dyets, Inc., Lehigh Valley, PA) as described previously. The FA group received a folate-adequate diet containing

2 mg/kg of folic acid. The FD group received a folate-deficient diet containing 0 mg/kg of folic acid. Diets were stored at -20°C . 1% succinyl sulfathiazole was added to all diets. One week after commencement of food ingestion, randomly selected mice from both FA and FD were injected intraperitoneally with 1,2-dimethylhydrazine HCl (DMH, 30 mg/kg body weight) in 10 mmol/liter of NaHCO_3 (Fisher Scientific) once a week for 6 weeks. Both food intake and body weights were checked twice weekly to monitor for signs of toxicity, e.g. weight loss, and the diets continued for 12 weeks. Young animals were 6 weeks old when the DMH treatment was initiated; whereas the old animals were 24-26 months old when the DMH treatment was initiated [34].

C. Aberrant Colonic Crypt (ACF) Analysis

Animals were anesthetized under CO_2 asphyxiation, the abdominal cavity was opened and the colon excised, rinsed with cold phosphate-buffered saline, cut longitudinally, and fixed flat overnight in 10% neutral buffered formalin. The colonic crypts were stained with 2 g/liter of methylene blue in phosphate-buffered saline for 5 min. The number of ACF and aberrant crypts per foci were determined by light microscopy at $\times 10$ magnification in a blinded manner [34].

D. Western Blot Analysis

Western blot analysis was performed using 200 μg of nuclear protein as previously described. Upon completion of SDS-PAGE, the region containing the protein(s) of interest was excised and prepared for Western blot analysis,

whereas the remaining portion of the gel was stained with GelCode blue stain reagent (Pierce Biotechnology) to ensure equal protein loading. Western analysis was accomplished using affinity purified polyclonal antisera developed against mouse β -*pol*. As an internal control for protein loading, membranes were reprobed with anti-Lamin B antibody (Santa Cruz Biotechnology, Santa Cruz, CA). The bands were visualized and quantified using a ChemImager™ System (AlphaInnotech, San Leandro, CA) after incubation in SuperSignal® West Pico Chemiluminescent Substrate (Pierce Biotechnology). Data are expressed as the integrated density value of the band per μ g of protein loaded [34].

E. Statistical Analysis

Statistical significance between means was determined using “unpaired t-test”. *P* values less than 0.05 were considered statistically significant.

CHAPTER 4

FIGURES

Figure 4-1: Experimental Design: WT and β -pol^{+/-} mice were fed either a folate-adequate (2 mg/kg, FA) or a folate-deficient (0 mg/kg,FD) diet for a period of twelve weeks. All the WT mice in this experiment were young (6 weeks old) when the carcinogenic treatment started. Whereas, there were two different groups of the β -pol^{+/-} mice that were fed a FD diet, one of which were young (6 weeks old) and the others were old animals (24-26 months old) when the carcinogenic treatment was first initiated. After the first week of following the respective diets, all groups followed the same treatment and were injected with a 30 mg/kg body weight of 1,2 dimethylhydrazine (DMH), a colon and liver carcinogen, for a period of 6 weeks. After these 6 weeks of consecutive treatments, the animals were sacrificed by CO₂ asphyxiation on week 12.

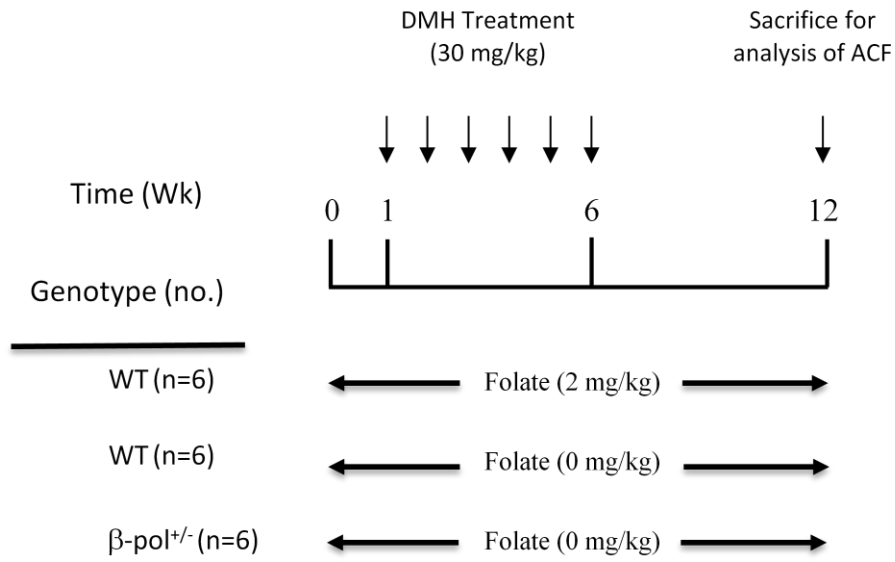

Figure 4-2: The impact of β -pol $^{+/-}$ on the ACF formation in colon of mice treated with DMH. WT (young “Y”) and β -pol $^{+/-}$ (Y or old) received either folate adequate (FA) or folate deficient (FD) diet and were subjected to intraperitoneal treatment with DMH for 6 weeks at 30 mg/kg body weight. After sacrifice, colons were processed as described under “Methods.” Colons were analyzed under light microscopy to visualize the number of ACF per mouse colon (ACF/mouse).

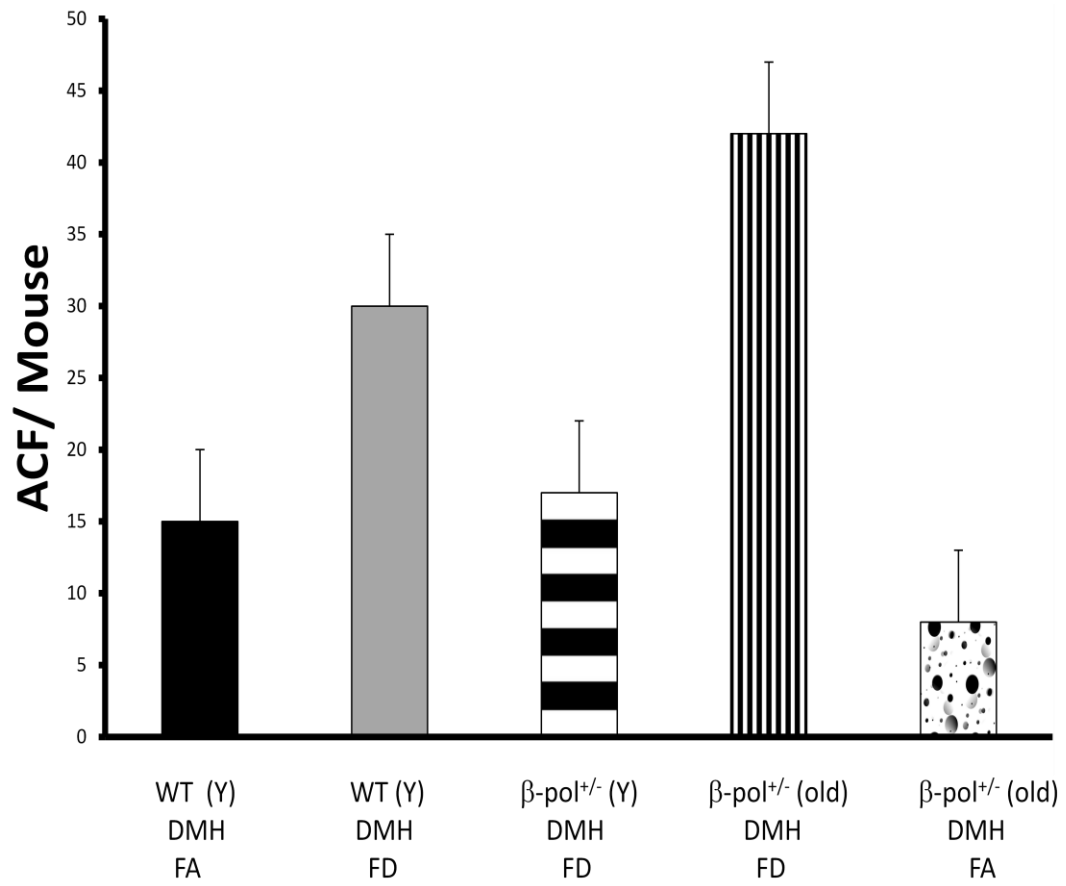

Figure 4-3: Effect of folate deficiency and DMH treatment on the protein levels of p-S6K in the young WT and β -pol^{+/-} mice. This figure represents the analysis of the phosphorylated S6K protein levels in mucosa of young (Y) WT and β -pol^{+/-} that received either folate adequate (FA) or folate deficient (FD) diet and were subjected to either no treatment (control) or intraperitoneal treatment with DMH for 6 weeks at 30 mg/kg body weight (DMH). The protein levels were quantified using Western blot analysis. Values represent an average (\pm SEM) of data obtained from 3 mice of each group and are representative of separate identical experiments. Values with different letter superscripts indicate significant differences at $p < 0.05$.

Figure 4-4: Effect of folate deficiency and DMH treatment on the protein levels of p-4E-BP in the young WT and β -pol^{+/-} mice. This figure represents the analysis of the phosphorylated 4E-BP protein levels in mucosa of young (Y) WT and β -pol^{+/-} that received either folate adequate (FA) or folate deficient (FD) diet and were subjected to either no treatment (control) or intraperitoneal treatment with DMH for 6 weeks at 30 mg/kg body weight (DMH). The protein levels were quantified using Western blot analysis. Values represent an average (\pm SEM) of data obtained from 3 mice of each group and are representative of separate identical experiments. Values with different letter superscripts indicate significant differences at $p < 0.05$.

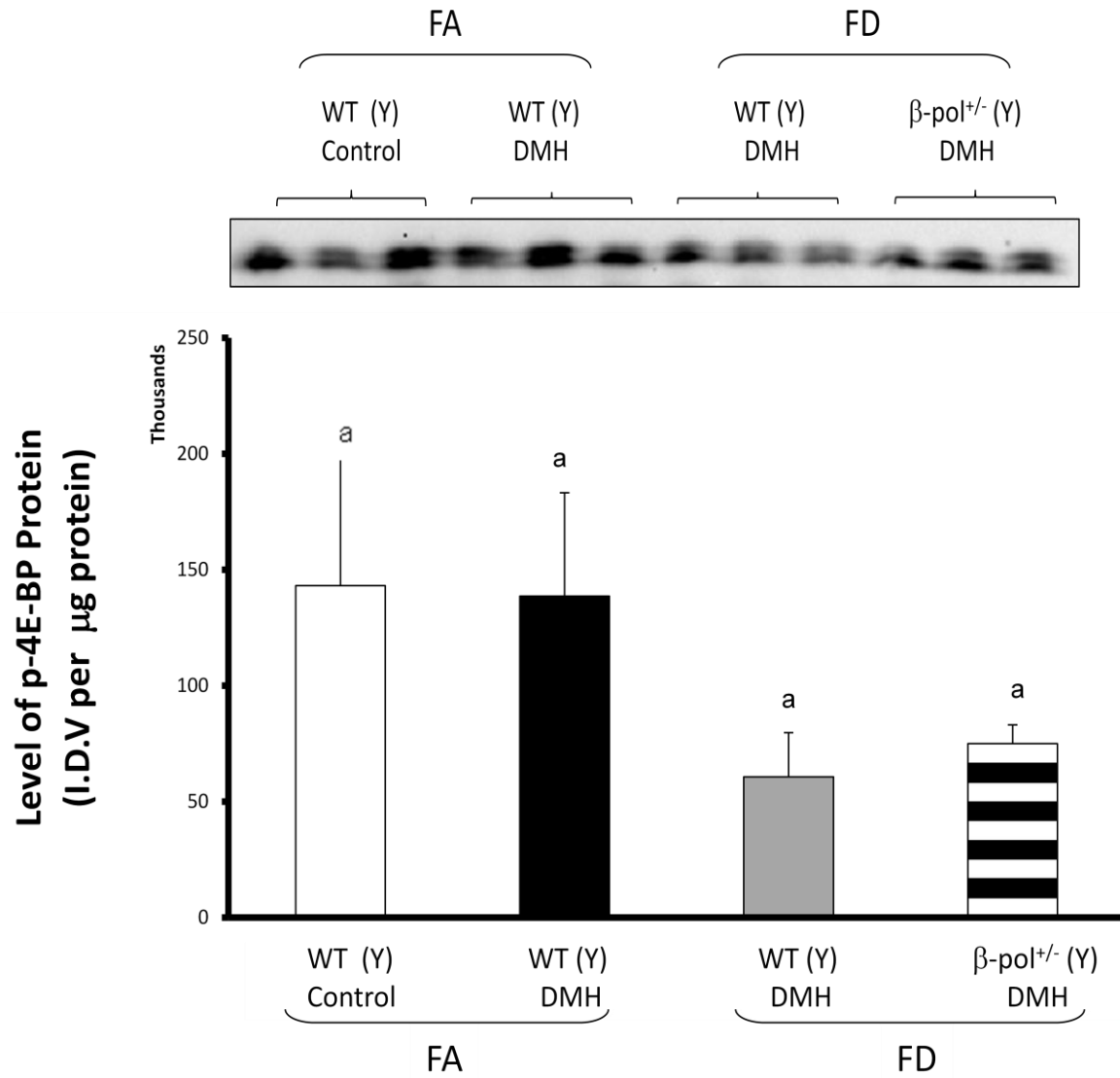

Figure 4-5: Effect of folate deficiency and DMH treatment on the protein levels of p-AKT in the young WT and β -pol^{+/-} mice. This figure represents the analysis of the phosphorylated AKT protein levels in mucosa of young (Y) WT and β -pol^{+/-} that received either folate adequate (FA) or folate deficient (FD) diet and were subjected to either no treatment (control) or intraperitoneal treatment with DMH for 6 weeks at 30 mg/kg body weight (DMH). The protein levels were quantified using Western blot analysis. Values represent an average (\pm SEM) of data obtained from 3 mice of each group and are representative of separate identical experiments. Values with different letter superscripts indicate significant differences at $p < 0.05$.

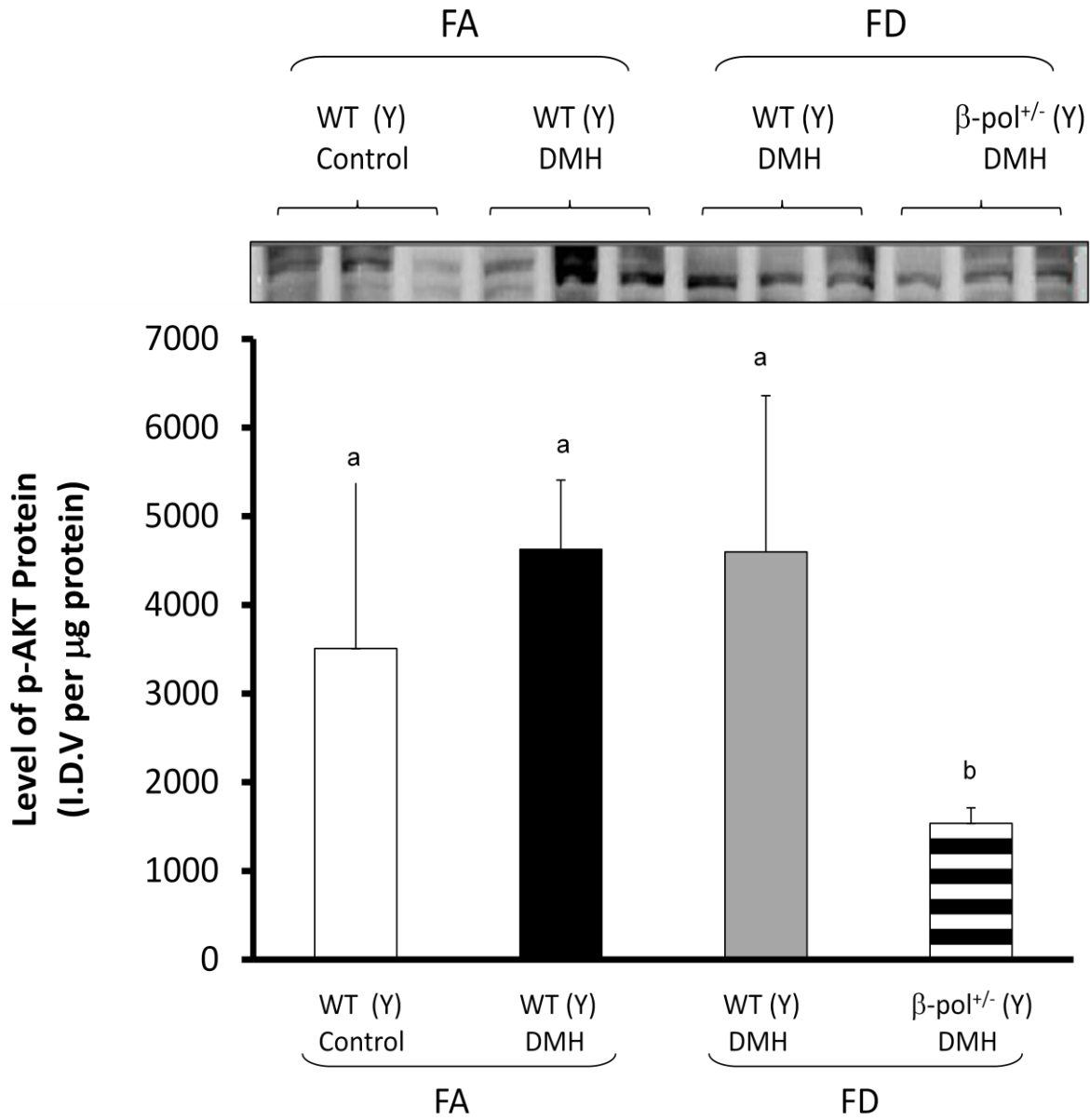

Figure 4-6: Effect of folate deficiency and DMH treatment on the protein levels of p-AMPK in the young WT and β -pol^{+/-} mice. This figure represents the analysis of the phosphorylated AMPK protein levels in mucosa of young (Y) WT and β -pol^{+/-} that received either folate adequate (FA) or folate deficient (FD) diet and were subjected to either no treatment (control) or intraperitoneal treatment with DMH for 6 weeks at 30 mg/kg body weight (DMH). The protein levels were quantified using Western blot analysis. Values represent an average (\pm SEM) of data obtained from 3 mice of each group and are representative of separate identical experiments. Values with different letter superscripts indicate significant differences at $p < 0.05$.

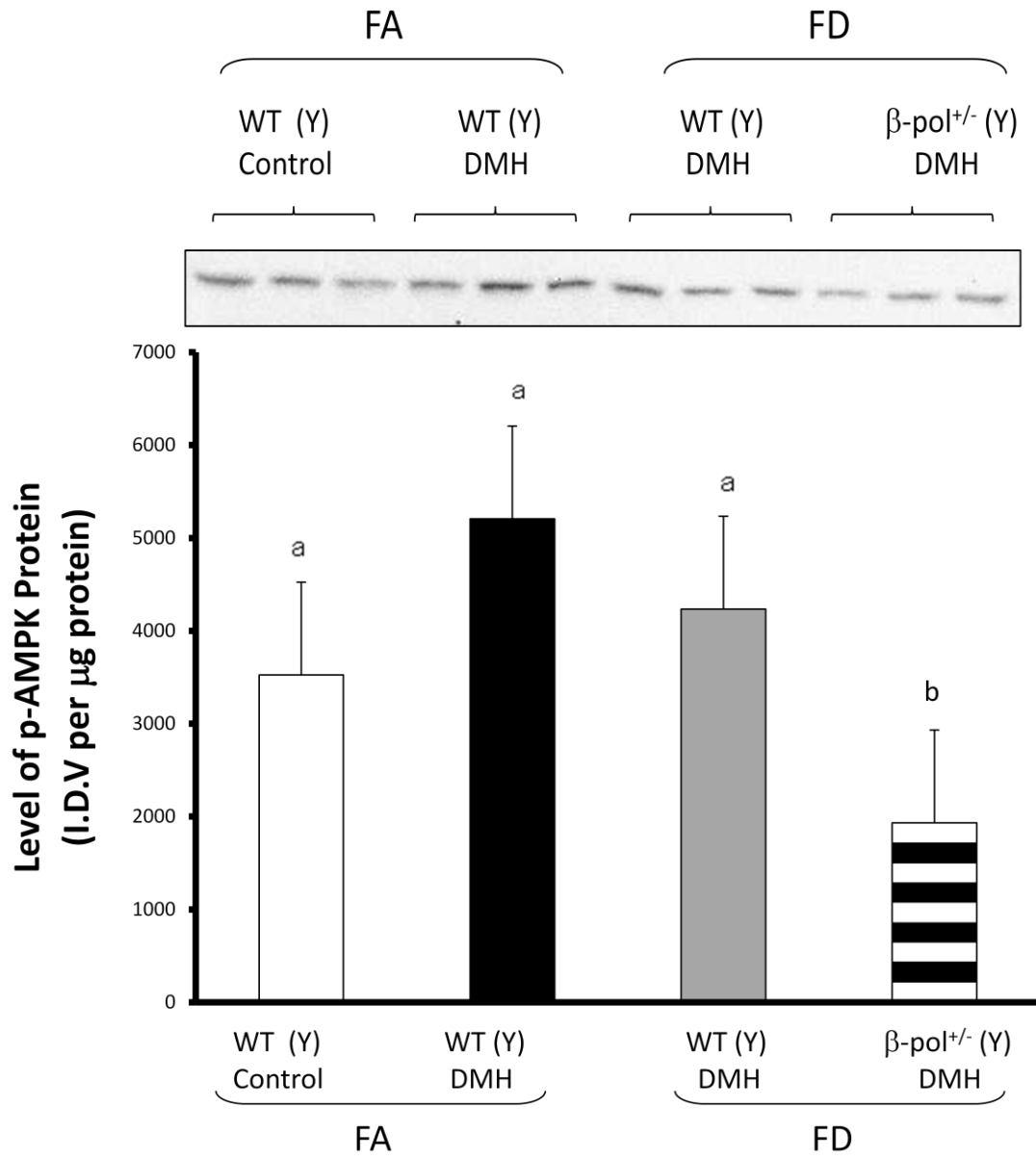

Figure 4-7: Effect of folate deficiency and DMH treatment on the protein levels of IPMK in the young WT and β -pol^{+/-} mice. This figure represents the analysis of IPMK protein levels in mucosa of young (Y) WT and β -pol^{+/-} that received either folate adequate (FA) or folate deficient (FD) diet and were subjected to either no treatment (control) or intraperitoneal treatment with DMH for 6 weeks at 30 mg/kg body weight (DMH). The protein levels were quantified using Western blot analysis. Values represent an average (\pm SEM) of data obtained from 3 mice of each group and are representative of separate identical experiments. Values with different letter superscripts indicate significant differences at $p < 0.05$.

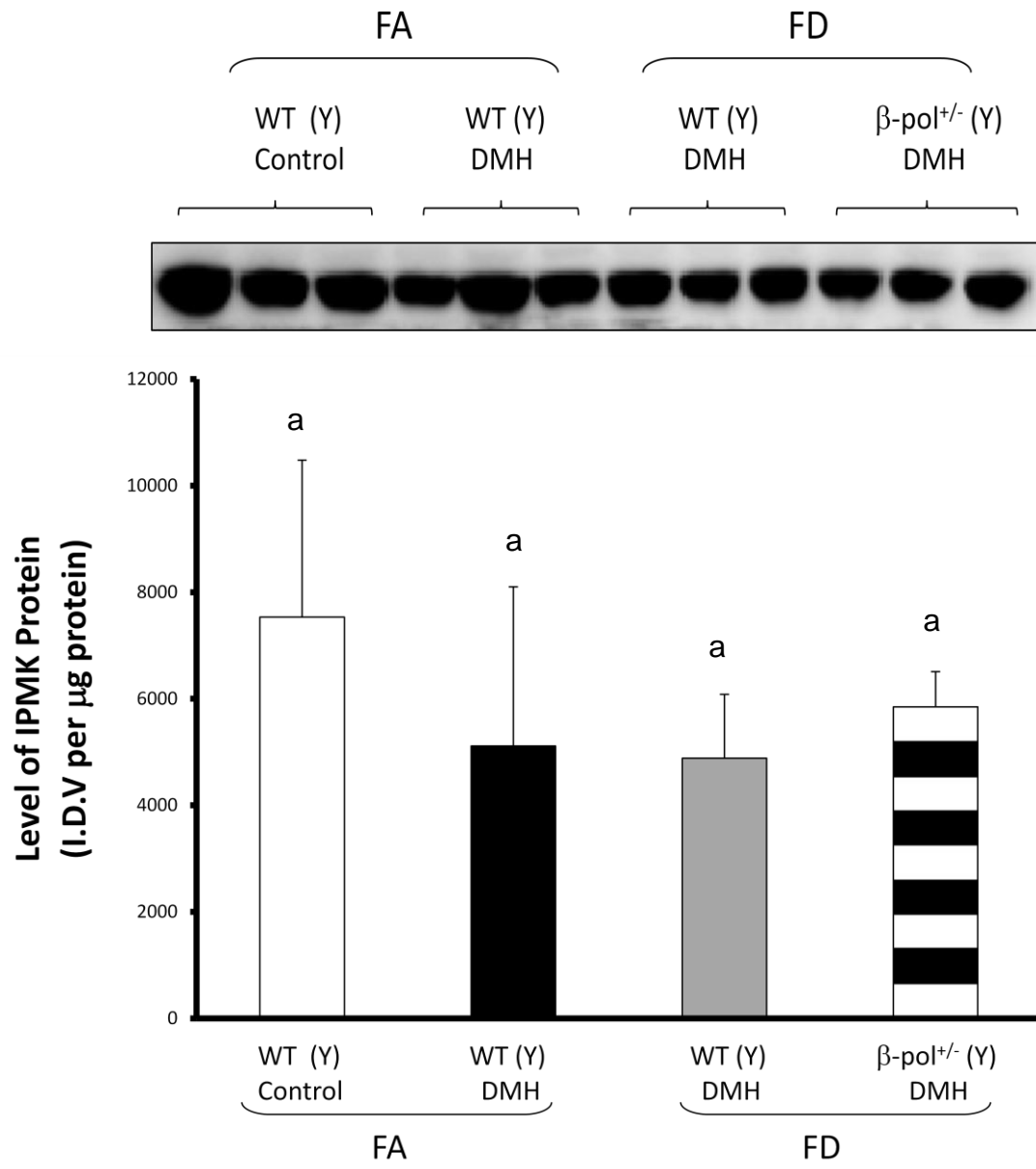

Figure 4-8: Effect of folate deficiency and DMH treatment on the cleavage of PARP in the young WT and β -pol^{+/-} mice. This figure represents the analysis of PARP cleavage in mucosa of young (Y) WT and β -pol^{+/-} that received either folate adequate (FA) or folate deficient (FD) diet and were subjected to either no treatment (control) or intraperitoneal treatment with DMH for 6 weeks at 30 mg/kg body weight (DMH). The cleavage was quantified using Western blot analysis. Values represent an average (\pm SEM) of data obtained from 3 mice of each group and are representative of separate identical experiments. Values with different letter superscripts indicate significant differences at $p < 0.05$.

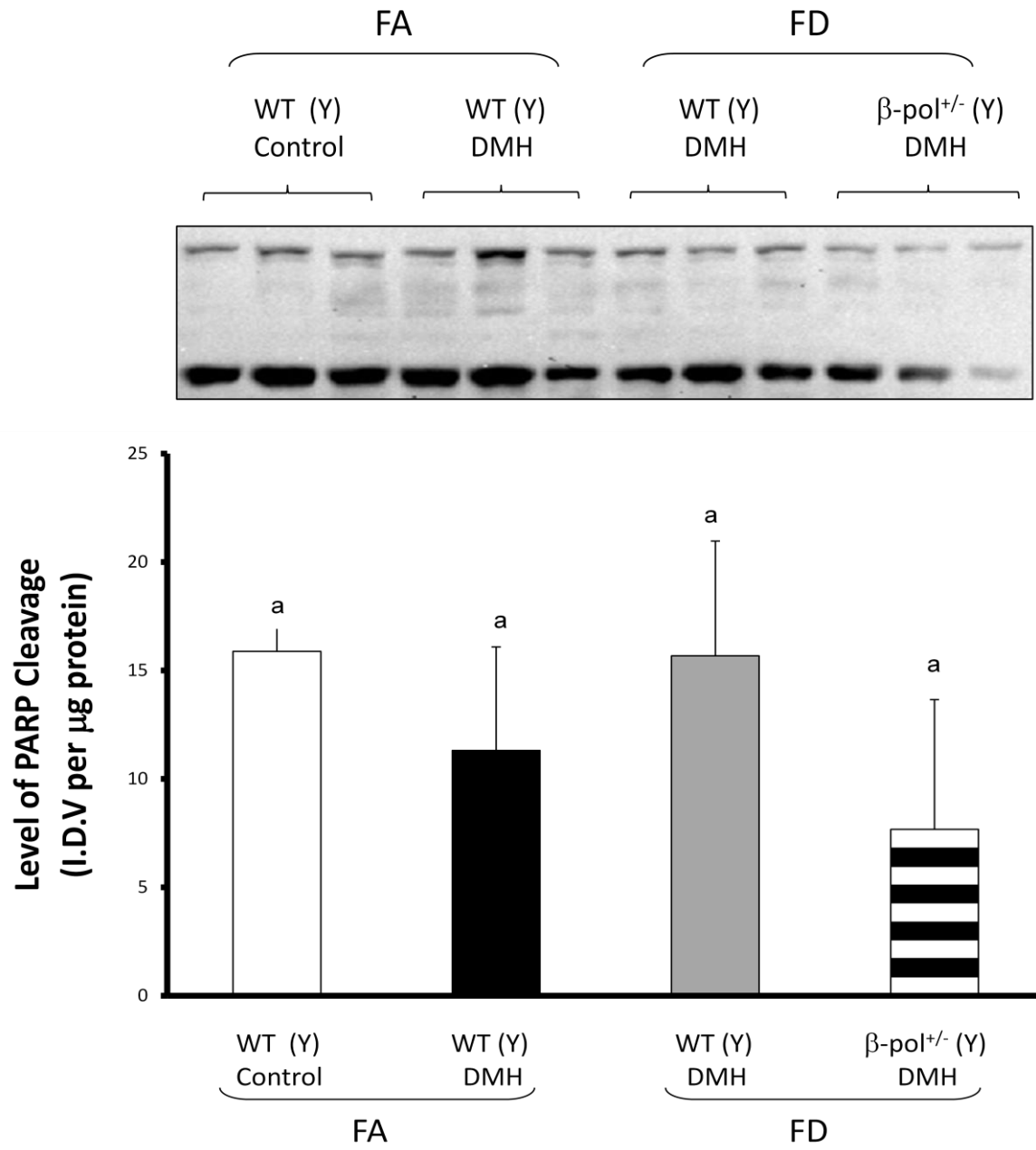

Figure 4-9: Effect of folate deficiency and DMH treatment on the protein levels of P53 in the young WT and β -pol^{+/-} mice. This figure represents the analysis of P53 protein levels in mucosa of young (Y) WT and β -pol^{+/-} that received either folate adequate (FA) or folate deficient (FD) diet and were subjected to either no treatment (control) or intraperitoneal treatment with DMH for 6 weeks at 30 mg/kg body weight (DMH). The protein levels were quantified using Western blot analysis. Values represent an average (\pm SEM) of data obtained from 3 mice of each group and are representative of separate identical experiments. Values with different letter superscripts indicate significant differences at $p < 0.05$.

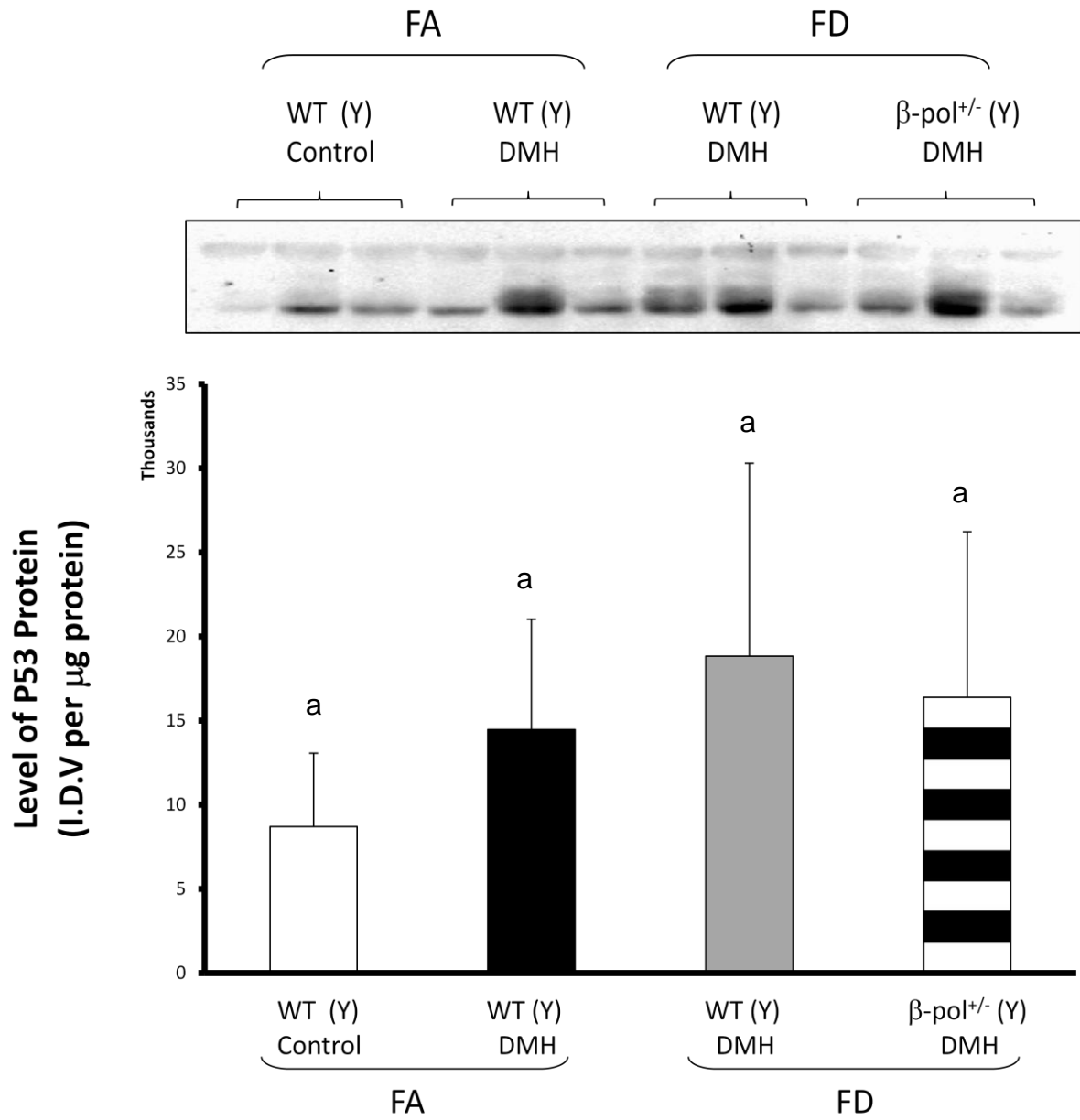

Figure 4-10: Effect of folate deficiency and DMH treatment on the protein levels of p-4E-BP in the young and old β -pol^{+/-} mice. This figure represents the analysis of the phosphorylated 4E-BP protein levels in mucosa of (young “Y”) WT and (Y or old) β -pol^{+/-} that received either folate adequate (FA) or folate deficient (FD) diet and were subjected to either no treatment (control) or intraperitoneal treatment with DMH for 6 weeks at 30 mg/kg body weight (DMH). The protein levels were quantified using Western blot analysis. Values represent an average (\pm SEM) of data obtained from 3 mice of each group and are representative of separate identical experiments. Values with different letter superscripts indicate significant differences at $p < 0.05$.

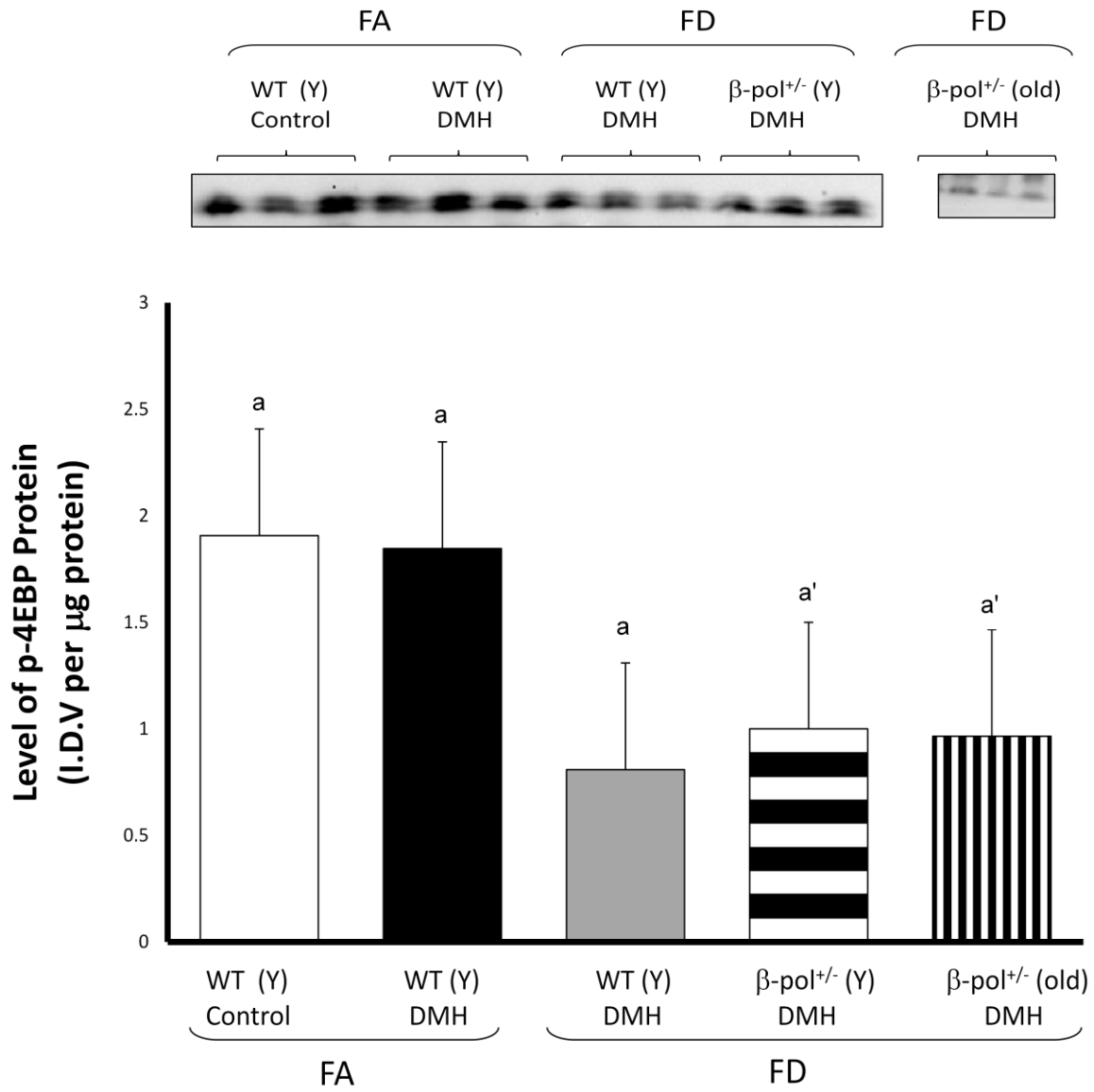

Figure 4-11: Effect of folate deficiency and DMH treatment on the protein levels of p-AKT in the young and old β -pol^{+/-} mice. This figure represents the analysis of the phosphorylated AKT protein levels in mucosa of (young “Y”) WT and (Y or old) β -pol^{+/-} that received either folate adequate (FA) or folate deficient (FD) diet and were subjected to either no treatment (control) or intraperitoneal treatment with DMH for 6 weeks at 30 mg/kg body weight (DMH). The protein levels were quantified using Western blot analysis. Values represent an average (\pm SEM) of data obtained from 3 mice of each group and are representative of separate identical experiments. Values with different letter superscripts indicate significant differences at $p < 0.05$.

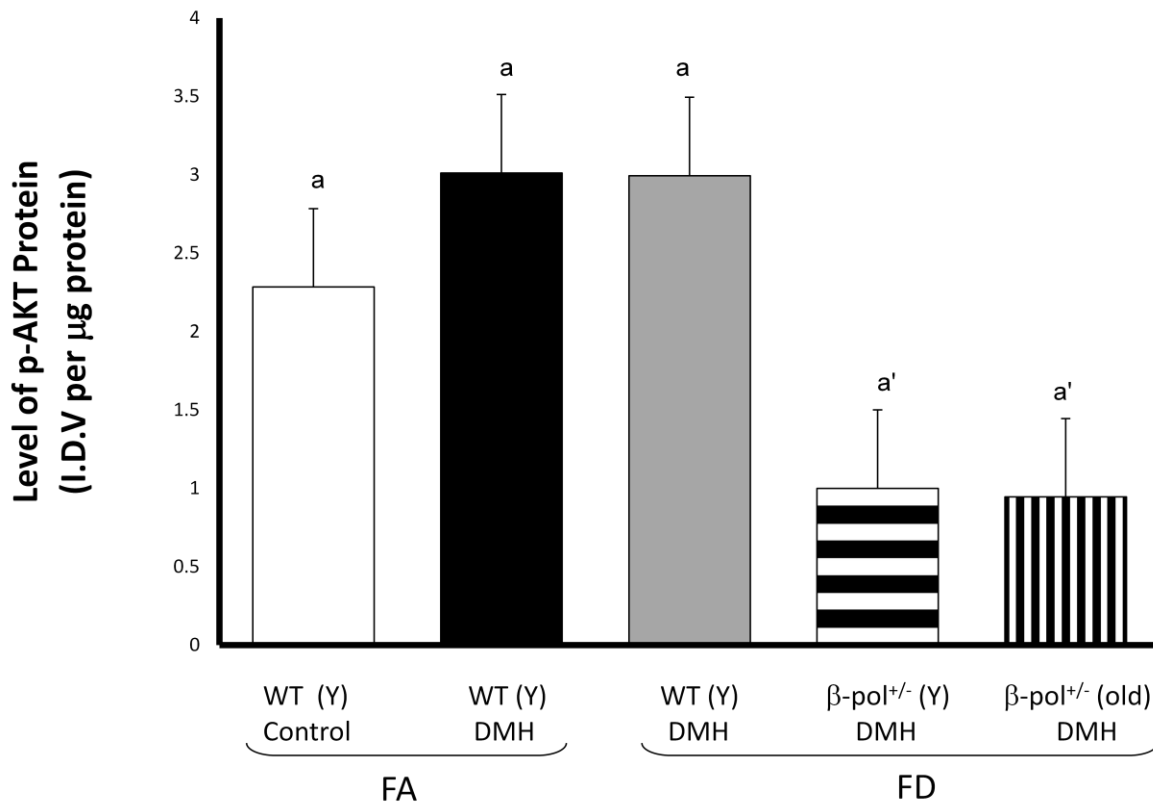
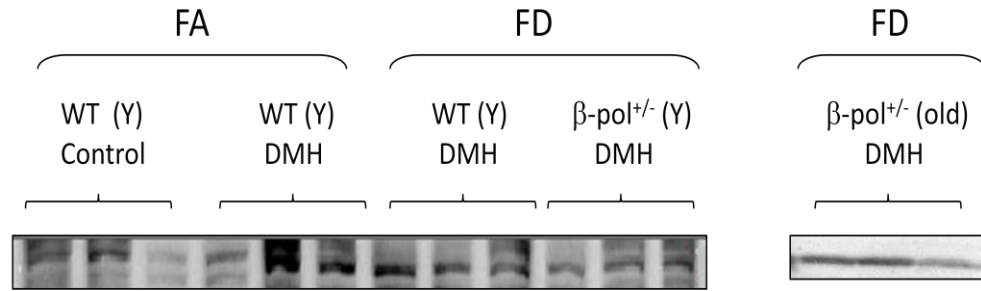

Figure 4-12: Effect of folate deficiency and DMH treatment on the protein levels of IPMK in the young and old β -pol^{+/-} mice. This figure represents the analysis of IPMK protein levels in mucosa of (young “Y”) WT and (Y or old) β -pol^{+/-} that received either folate adequate (FA) or folate deficient (FD) diet and were subjected to either no treatment (control) or intraperitoneal treatment with DMH for 6 weeks at 30 mg/kg body weight (DMH). The protein levels were quantified using Western blot analysis. Values represent an average (\pm SEM) of data obtained from 3 mice of each group and are representative of separate identical experiments. Values with different letter superscripts indicate significant differences at $p < 0.05$.

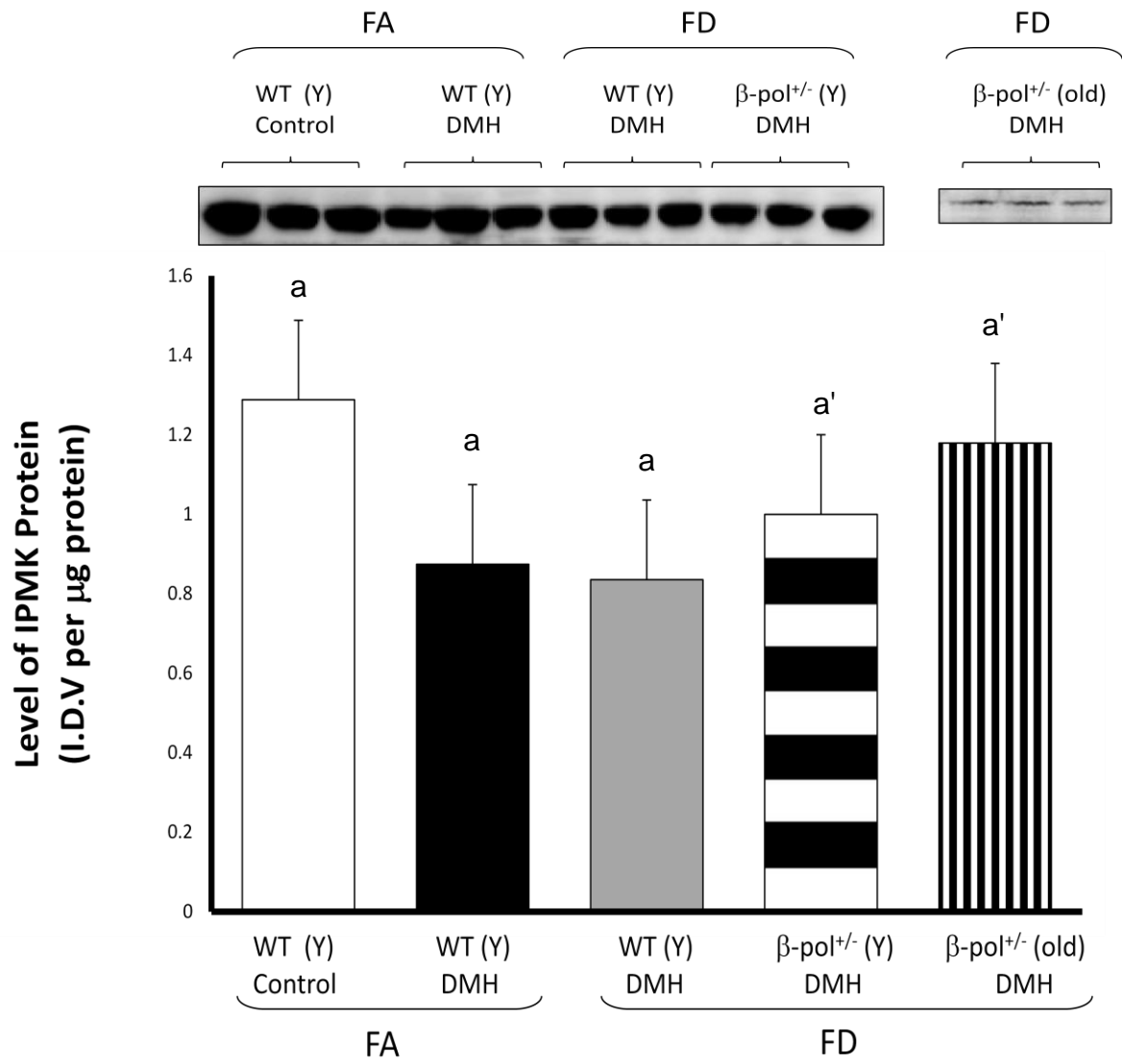

Figure 4-13: Effect of folate deficiency and DMH treatment on the cleavage of PARP in the young and old β -pol^{+/-} mice. This figure represents the analysis of PARP cleavage in mucosa of (young “Y”) WT and (Y or old) β -pol^{+/-} that received either folate adequate (FA) or folate deficient (FD) diet and were subjected to either no treatment (control) or intraperitoneal treatment with DMH for 6 weeks at 30 mg/kg body weight (DMH). The cleavage was quantified using Western blot analysis. Values represent an average (\pm SEM) of data obtained from 3 mice of each group and are representative of separate identical experiments. Values with different letter superscripts indicate significant differences at $p < 0.05$.

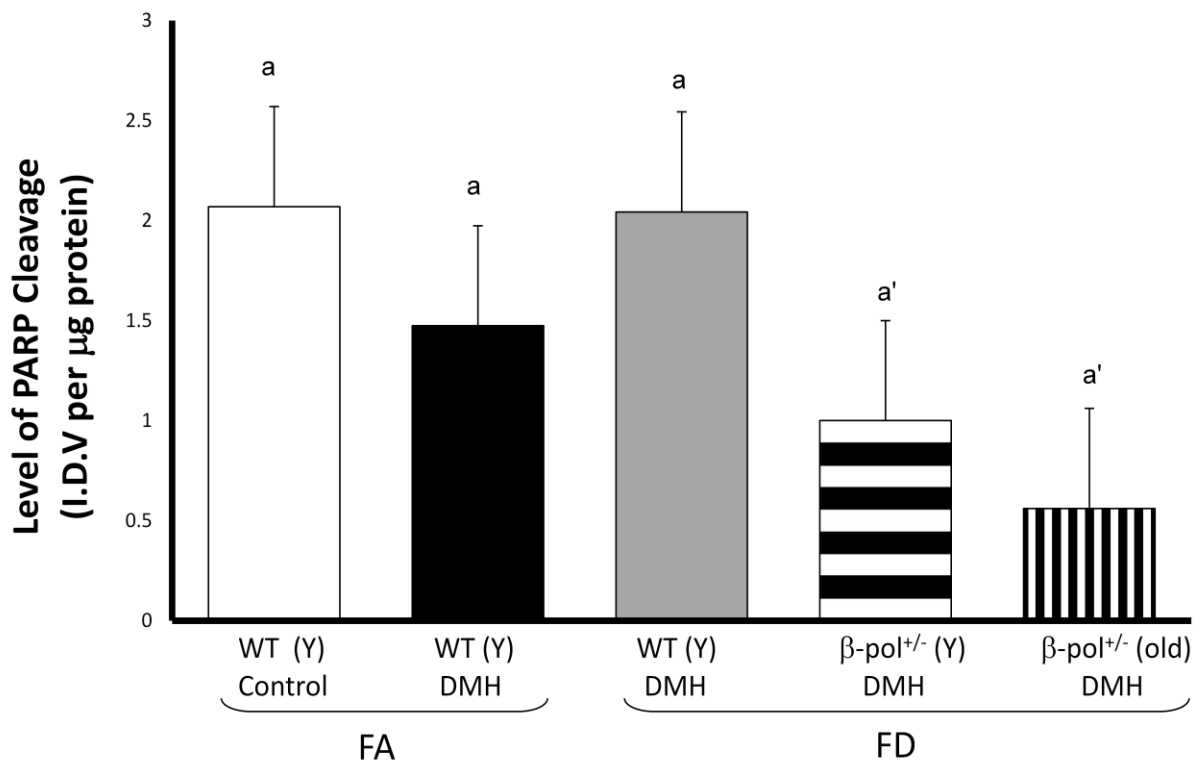
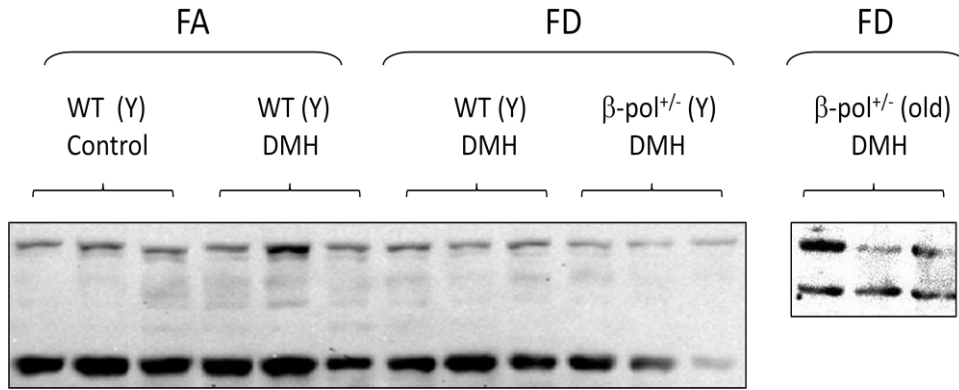
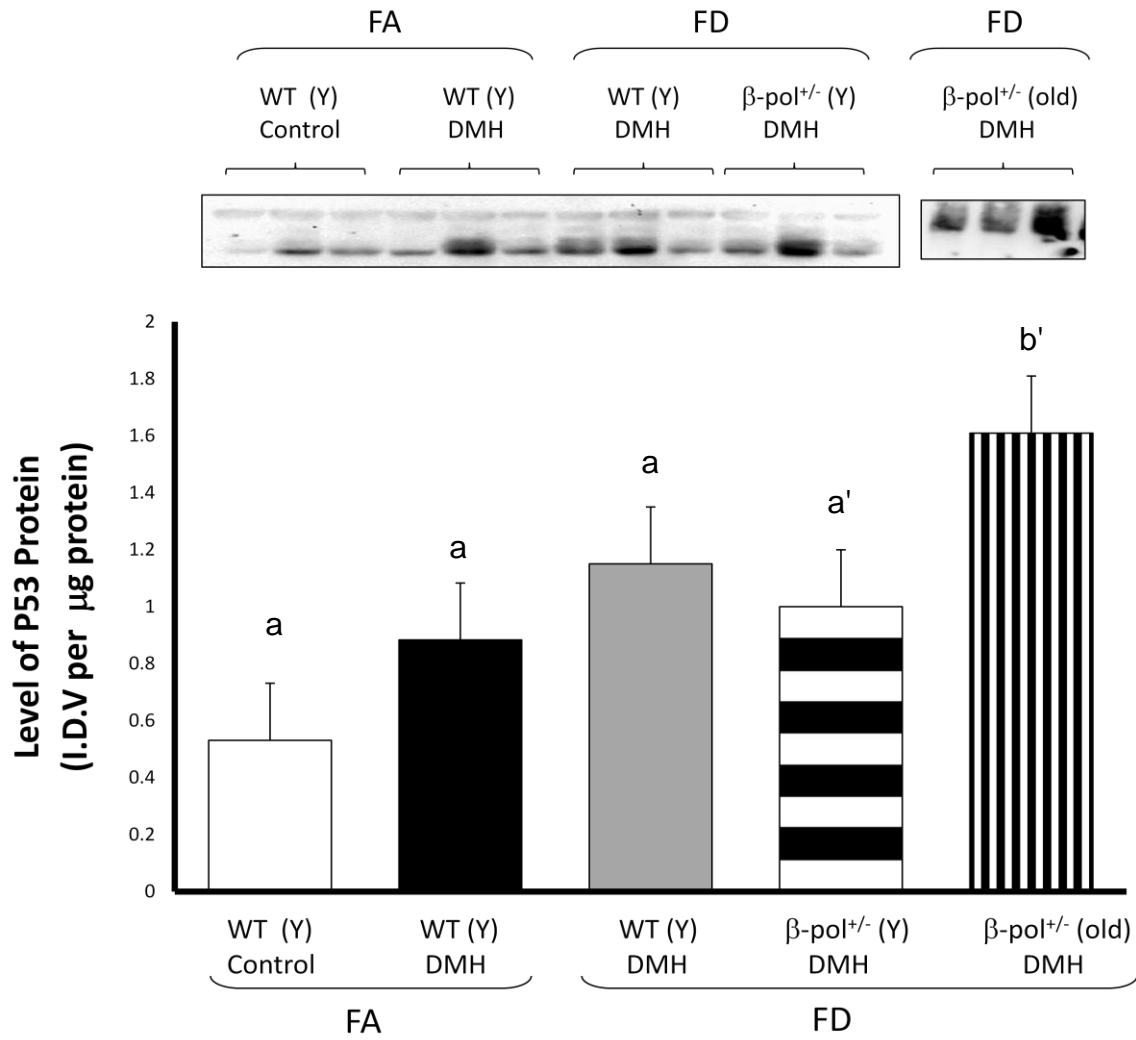

Figure 4-14: Effect of folate deficiency and DMH treatment on the protein levels of P53 in the young and old β -pol^{+/-} mice. This figure represents the analysis of P53 protein levels in mucosa of (young “Y”) WT and (Y or old) β -pol^{+/-} that received either folate adequate (FA) or folate deficient (FD) diet and were subjected to either no treatment (control) or intraperitoneal treatment with DMH for 6 weeks at 30 mg/kg body weight (DMH). The protein levels were quantified using Western blot analysis. Values represent an average (\pm SEM) of data obtained from 3 mice of each group and are representative of separate identical experiments. Values with different letter superscripts indicate significant differences at $p < 0.05$.



CHAPTER 5

RESULTS/ DISCUSSION

Previous studies have shown that there is a tight correlation between folate deficiency, aging, and carcinogenesis which might be explained by the increased mutagenesis. The base excision repair pathway (BER) is understood to sustain the genomic stability by repairing the endogenous DNA damage and damages induced by oxidizing and alkylating agents. Any changes in the BER homeostasis create an increase in the genomic instability, which has been associated with carcinogenesis. Folate deficiency has shown to induce the development of cancer by interrupting the BER pathway. It is important to understand the effect of folate deficiency and aging on the progression of tumors in the liver of DNA polymerase β haploinsufficient (β -pol^{+/-}) mice treated with a carcinogen. An experimental design has been developed in our laboratory in order to elucidate that folate restriction provides a protective action on tumorigenesis with old DNA β -pol^{+/-} mice in response to a carcinogen treatment. Wild type (WT) and β -pol^{+/-} mice were given either a folate adequate (2mg/kg, FA) or a folate deficient diet (0mg/kg, FD) for a period of twelve weeks (figure 4-1). All the WT mice in this experiment were young (6 weeks old) when the carcinogenic treatment started; whereas, there were two different groups of the β -pol^{+/-} mice that were fed a FD diet, one of which were young (6 weeks old) and the others were old animals (24-26 months old) when the carcinogenic treatment was first initiated. After the first week of following the respective diets,

all groups followed the same treatment and were injected with a 30 mg/kg body weight of 1,2 dimethylhydrazine (DMH), a colon and liver carcinogen, for a period of 6 weeks. After these 6 weeks of consecutive treatments, the animals were sacrificed by CO₂ asphyxiation on week 12. After these animals were sacrificed, the abdominal cavity was opened and the colon was removed and handled properly in order to analyze the number of Aberrant Colonic Crypt (ACF). Figure (4-2) illustrates the ACF count visualized per mouse colon (ACF/mouse) after the colons were analyzed under light microscopy. Previous studies have found that untreated WT and β -pol^{+/-} mice did not show any ACF in their colon [34]. This finding proved the fact that β -pol^{+/-} mice with a deficiency in the BER capacity were unable to stimulate ACF in mice without any DMH treatment. This indicates that the DMH treatment promotes the induction of ACF. Folate deficiency resulted in a significant increase (~50%) in ACF formation in young WT animals treated with DMH as compared with the FA counterpart (figure 4-2). This indicates that folate deficiency leads to a significant increase in colon carcinogen in response to DMH [34]. Moreover, the figure clearly indicates a significant decline (~43%) in the formation of ACF in β -pol^{+/-} mice when being compared to their WT counterparts with a FD diet. This finding indicates that the development of ACF is lessened in treated- β -pol^{+/-} mice when folate is deficient. After these findings, it is interesting to examine the effect of age, along with folate deficiency, on the development of ACF in the colons of treated- β -pol^{+/-} mice. Figure (4-2)

indicates a dramatic increase (60%) in ACF counts in treated- β -pol^{+/-} old mice consuming a folate deficient diet as compared to their young counterparts. This finding anticipates that age does display a dramatic development of colon carcinogenesis in treated- β -pol^{+/-} mice when folate is deficient. However, a significant difference is found in their FA counterparts. This indication should not be considered due to the fact that the FA treated- β -pol^{+/-} old mice were not able to sustain more than 3 doses of DMH like the rest of the groups. This finding indicates that the treated- β -pol^{+/-} old mice were able to sustain the entire treatment when folate was deficient. Thus, it is anticipated that folate deficiency provides a protective role in treated- β -pol^{+/-} old mice, despite the dramatic increase in the development of ACF.

Data from our lab, microarray analysis, have observed the effect of folate deficiency on the expression of the mammalian target of rapamycin (mTOR) signaling pathway in the colon of the young β -pol^{+/-} mice that were treated with DMH. The mTOR pathway (figure 1-3) incorporates both intracellular and extracellular signals and plays an important role in the regulation of cell growth, proliferation and survival. It has been shown that this pathway is triggered during several cellular processes (such as: tumor development, adipogenesis, and insulin resistance) and is deregulated in the conditions of cancer and type 2 diabetes [26]. Interestingly, the mTOR pathway was observed to be altered in the young animals. Based on these findings, it is interesting to observe the

mechanism behind the mTOR signaling pathway on other tissues of the body, example liver cells, of the same mice models described earlier.

In order to provide a clear comparison of the upstream and downstream signaling mechanisms of the substrates involved in the regulation of the mTOR pathway, figures (4-3 through 4-9) will provide a comparison between the different groups of the young mice. Whereas, figures (4-10 through 4-14) will provide the same findings found in figures (4-3 through 4-9) in addition to the DMH treated β -pol^{+/-} old mice group that was fed a folate deficient diet.

The mTOR complex 1 (mTORC1) controls the synthesis of protein, which is necessary for cell growth, via various downstream factors. This protein synthesis is normally promoted by the phosphorylation of S6 kinase (S6K-P) and 4E binding protein (4E-BP). Figure (4-3) illustrates the effect of folate deficiency and DMH treatment on the protein levels of p-S6K in the young WT and β -pol^{+/-} mice. The figure shows an insignificant difference in the phosphorylation levels of S6K protein in both treated and untreated WT young mice when consuming a FA diet. However, a significant increase of approximately 46% in the phosphorylation of S6K protein has been reported in young WT mice that were treated with DMH, in an FD environment compared to their FA counterparts. Interestingly, this level drops significantly (~50%) in the young β -pol^{+/-} mice that were treated with DMH, when folate was deficient. Similarly, the levels of 4E-BP phosphorylation (figure 4-4) did not show any significant difference in treated and untreated WT

young mice, consumed a folate adequate diet. Whereas, 4E-BP levels of phosphorylation dropped significantly (~60%) in young, treated WT mice when folate was deficient, compared to their FA counterparts. No significant difference was observed in their β -pol^{+/-} counterparts. Hence, folate restriction could possibly lead to a decline in the activation of mTORC1, which attenuates the activation of S6K and the inhibition of 4E-BP. This action could alter the protein synthesis, proliferation, and cell growth.

Under normal conditions, AKT (aka protein B kinase) controls the cell proliferation and endurance, as well as controlling nutrient metabolisms by the proliferation of some proteins [28]. The growth factors (such as insulin) stimulate the mTORC1 which in turn promotes the phosphorylation of the TSC2 by the activation of AKT. Moreover, adenosine monophosphate -activated kinase (AMPK) has a powerful ability to sense any energy imbalances and react to any fluctuations in the AMP; ATP ratio [30]. The levels of AKT and AMPK protein, (figures 4-5 and 4-6 respectively) observed almost similar patterns. An insignificant increase in the phosphorylation of AKT and AMPK has been indicated in the treated and untreated young WT animal with an FA diet and treated WT young mice with folate deficiency. However, a significant decrease (~66%) in the phosphorylation of AKT, along with a 50% reduction in the phosphorylation of AMPK, is shown with the treated young β -pol^{+/-} mice when folate was deficient, compared to their young counterparts. Hence, folate

restriction attenuates the activation of AKT and alters the AMPK phosphorylation resulting in the inhibition of the mTORC1 pathway.

Inositol polyphosphate multikinase (IPMK) has been classified as an mTOR cofactor and a significant component in stimulating the signaling pathway by responding to amino acid levels [30]. Figure (4-7) indicates that the level of IPMK expression is slightly highest among the untreated young WT mice when folate was adequate. A ~33% reduction in the expression is indicated in the other groups, ultimately reducing mTOR activation.

The protein 53 (p53), that is responsible for activating the DNA repair proteins when the DNA is being damaged, functions as an anti-cancer component [29]. Poly (ADP-ribose) polymerase (PARP) is an enzyme that plays an important role in responding to cellular death. The alterations in the levels of p53 expression and in the cleavage of PARP are marks of apoptosis. Figure (4-8) shows that the PARP cleavage is higher (~37%) in untreated young WT than in the treated ones, when consuming a folate adequate diet. These levels are higher in treated WT young mice consuming a folate deficient diet. A significant reduction (~53%) is shown in their β -pol^{+/-} counterparts. Figure (4-9) indicates that there is a slight increase in the level of P53 expression in the treated young WT mice in comparison with the untreated mice when consuming a FA diet. However, a 20-25% increase is indicated in the animals that were following a FD

diet. These findings indicate that there has been a deregulation in the apoptotic pathway in the liver of young animals.

Figures (4-10 through 4-14) compare the β -pol^{+/-} old mice that were treated with DMH when consuming a FD diet with their young counterparts. Figures (4-10, 4-11, and 4-12) indicate insignificant change in the levels of p-4E-BP, p-AKT, and IPMK protein expression in the β -pol^{+/-} old mice treated with DMH and consuming a FD diet compared to their young counterparts. However a slight decrease in the PARP cleavage and a significant increase in P53 expression are found in treated β -pol^{+/-} old mice consuming FD diet as compared to their young counterparts (Figures 4-13 and 4-14). Thus, these findings confirm the fact that apoptosis is being significantly altered. We actually see differential patterns with different factors, thus further experiments are needed in order to more understand the mechanism behind the folate deficiency and aging on the liver of β -pol^{+/-} mice, when treated with a carcinogens.

CHAPTER 6

CONCLUSION

Several studies have indicated that there is a strong correlation between folate deficiency, aging, and carcinogenesis which might be explained by the increased mutagenesis and tumorigenesis. It is significant to comprehend the effect of folate deficiency and aging on the progression of tumors in the liver of β -pol^{+/-} mice treated with a carcinogen. Previous studies have found that WT and β -pol^{+/-} mice, that were untreated with DMH, did not show any ACF in their colon. However, folate deficiency resulted in a significant increase in ACF formation in young WT animals treated with DMH as compared with the FA counterpart. This finding indicates that folate deficiency leads to a significant increase in colon carcinogen in response to DMH. However, our data clearly demonstrated that the development of ACF is lessened in treated- β -pol^{+/-} mice when folate is deficient. After these findings, it is interesting to examine the effect of age, along with folate deficiency, on the development of ACF in the colon of treated- β -pol^{+/-} mice. We have anticipated that age does display a dramatic development of colon carcinogenesis in treated- β -pol^{+/-} mice when folate is deficient. However, FD may have exerted an anti-cancer protective role to treated- β -pol^{+/-} old mice since they were able to sustain the entire treatment, unlike their FA counterparts.

Previous studies in our lab have studied the effect of folate deficiency on the mTOR signaling pathway in the colon of the young β -pol^{+/-} mice that were treated with DMH. These findings increased our curiosity to examine the mechanism behind the mTOR signaling pathway on other tissues of the body, example liver cells, of the same mice models described earlier. Our experiments indicate that there has been a modulation in the signaling of mTOR pathway in the liver of young and old animals. This indicates that apoptosis is being significantly altered. Therefore, folate deficiency might have a protective role in the β -pol^{+/-} young and old mice that have been treated with a colon and liver carcinogen. However, our studies are insufficient and need further studies to more understand the mechanism behind the folate deficiency and aging on the liver of β -pol^{+/-}, when treated with a carcinogens.

REFERENCES

1. Maulik N, Maulik G. *Nutrition, Epigenetic Mechanisms, and Human Disease*. Taylor and Francis Group: 2011.
2. Combs GF. *The Vitamins, Fundamental aspects in Nutrition and Health*. Second edition. Academic Press: 1998.
3. Baily RL, McDowell MA, Dodd KW, Gahche JJ, Dwyer JT, Picciano MF. Total folate and folic acid intakes from foods and dietary supplements of US children aged 1-13y. *Am J Clin Nutr*. 2010;92:353-8.
4. Crider KS, Bailey LB, Berry RJ. Folic Acid Food Fortification- Its History, Effect, Concerns, and future Directions. *Nutrients*. 2011;3:370-384.
5. Duthie SJ. Folate and cancer: how DNA damage, repair, and methylation impact on colon carcinogenesis. *Springer*.2010;34:101-109.
6. Kim Y. Folate and colorectal cancer: An evidence- based critical review. *Mol. Nutr. Food Res*.2007;51:267-292.
7. Hickson ID. *Base excision Repair of DNA Damage*. Landes Bioscience and Chapman & Hall:1997.
8. Fukagawa NK. Aging: Is Oxidative Stress a Marker or Is It Casual? *The Society for Experimental Biology and Medicine*. 1999;99:2223-0293.

9. Kim SY, Park SC. Physiological antioxidative network of the bilirubin system in aging and age-related diseases. *Front. Pharmacol.* 2012;10:3389.
10. Thomas AE. *DNA repair: damage, repair mechanisms, and aging*. Publication unknown: 2010.
11. Wei Q, Li L, Chen DJ. *DNA repair, genetic instability, and cancer*. World Scientific Publishing Co: 2007.
12. Ramadan K, Shevelev I, Hübscher U. The DNA-polymerase-X family: controllers of DNA quality? *Nature Publishing Group*. 2004;5:1038.
13. Idriss H, Al-Assar O, Wilson SH. Molecules in focus DNA polymerase β . *Elsevier Science*. 2002;34:321-324.
14. Canitrot Y, Fre'chet M, Servant L, Cazaux C, Se'Bastien Hoffmann J. Overexpression of DNA polymerase β : a genomic instability enhancer process. *Instabilite' Ge'ne'tique et Cancer*. 1999;13:1107–1111.
15. Chagovetz AM, Sweasy JB, Preston BD. Increased Activity and Fidelity of DNA Polymerase β on Singlenucleotide Gapped DNA. *The American Society for Biochemistry and Molecular Biology*. 1997;272:27501–27504.
16. Guo Z, Zheng L, Dai H, Zhou H, Xu H, Shen B. Human DNA polymerase β polymorphism, Arg137Gln, impairs its polymerase activity and interaction with PCNA and the cellular base excision repair capacity. *Nucleic Acids Research*. 2009;37:3431–3441.

17. Canitrot Y, Se´ Bastien Hoffmann J, Calsou P, Hayakawa H, Salles B, Cazaux C. Nucleotide excision repair DNA synthesis by excess DNA polymerase β : a potential source of genetic instability in cancer cells. *Groupe 'Instabilite´ ge´ne´tique et cancer*. 2000;14:1765–1774.
18. Starcevic D, Dalal S, Sweasy JB. Is there a Link Between DNA Polymerase β and Cancer? *Landles Bioscience*. 2004;8:998-1001.
19. Tannoudji MC, Babinet C. Beyond 'knock-out' mice: new perspectives for the programmed modification of the mammalian genome. *Molecular Human Reproduction*. 1998;4:929-938.
20. Sobol R, Horton JK, Kuhn R, Gu H, Singhal RK, Prasad R, Rajewsky K, Wilson S. Requirements of mammalian DNA polymerase- β in base excision repair. *Nature publishing group*. 1996;379:183.
21. Cabelof DC, Guo Z, Raffoul JJ. Excision Repair Deficiency Caused by Polymerase β Haploinsufficiency : Accelerated DNA Damage and Increased Mutational Response to Carcinogens. *Cancer Res*. 2003;63:5799-5807.
22. Cabelof DC, Ikeno Y, Nyska A. Haploinsufficiency in DNA Polymerase β Increases Cancer Risk with Age and Alters Mortality Rate. *Cancer Res*. 2006;66:7460-7465.
23. Cabelof DC, Raffoul JJ, Nakamura J, Kapoor D, Abdalla H, Heydari AR. Imbalanced Base Excision Repair in Response to Folate Deficiency Is

- Accelerated by Polymerase β Haploinsufficiency. *The Journal of Biological Chemistry*. 2004;279:36504-36513.
24. Ventrella-Lucente L, Unnikrishnan A, Pilling AB, Patel H, Kushwaha D, Dombkowski A, Schmelz E, Cabelof DC, Heydari AR. Folate Deficiency Provides Protection against Colon Carcinogenesis in DNA Polymerase β Haploinsufficient Mice. *Journal of Biological Chemistry*. 2010;285:19246-19258.
25. Simon KW, Ma H, Dombkowski AA, Cabelof DC. Aging alters folate homeostasis and DNA damage response in colon. *Mechanisms of Aging and Development*. 2012;133:75-82.
26. Zoncu R, Efeyan A, Sabatini DM. mTOR: from growth signal integration to cancer, diabetes, and aging. *Molecular Cell Biology*. 2011;12:21
27. Wellen K E, Thompson C B. Cellular Metabolic Stress: Considering How Cells Respond to Nutrient Excess. *Cell Press*. 2010;40: 323-332.
- 28: Guertin DA and Sabatini D. An expanding role for mTOR in cancer. *Journal*. 2005;11:353-361.
29. Levine A J, Hu W, Feng Z. The p53 pathway: what questions remain to be explored? *Cell Death Differ*. 2006;13:1027-1036.
30. Lee JY, Kim Y, Park J, Kim S. Inositol polyphosphate multi-kinase signaling in the regulation of metabolism. *New York Academy of Sciences*. 2012;1271:68-74.

31. Ethier C, Tardif M, Arul L, Poirier GG. PARP-1 Modulation of mTOR Signaling in Response to a DNA Alkylating Agent. *PLOS ONE*. 2012;7:47978.

ABSTRACT**EFFECT OF FOLATE DEFICIENCY AND AGING ON mTOR SIGNALING NETWORK IN THE LIVER OF DNA POLYMERASE β HAPLOINSUFFICIENT MICE**

by

AMANDA ARRABI**August 2013****Advisor:** Dr. Ahmad R. Heydari**Major:** Nutrition and Food Science**Degree:** Masters of Science

The interaction between the dietary nutrients and the human genome causes some alterations in the molecular pathways that could significantly impact the development of cancer. The main approach to such concerns is to closely observe how the diet modifies the gene expressions that control several cellular processes in the human body. Folate deficiency (FD) has established an important role in modulating the base excision repair homeostasis altering the development of tumors and cancer. We anticipate that age and FD may have exerted an anti-cancer protective role in DNA polymerase β haploinsufficient (β -pol^{+/-}) mice that are treated with a carcinogen. We hypothesize that dietary folate restriction alters mTOR signaling network in the liver to provide protection

against cancer in β -pol^{+/-} young and old mice that have been treated with a carcinogen.

AUTOBIOGRAPHICAL STATEMENT

AMANDA ARRABI

Education:

Graduating- August 2013	Master of Science in Nutrition and Food Science PhD Track. Wayne State University, Detroit, MI
June 2013	Coordinated Program in Dietetics Currently Registration Eligible Wayne State University, Detroit, MI
June 2011	Bachelor of Science in Nutrition and Dietetics American University of Beirut, Lebanon

Awards, Memberships & Volunteer Work

Wayne State University Graduate Teaching Assistant Award, 2013
 Wayne State University Graduate Professional Scholarship for the academic years of 2012-2013 and 2013-2014
 Southeastern Michigan Dietetic Association Graduate Scholarship Award, 2013
 Member of the WSU Nutrition and Food Science Graduate Student Organization, 2011-Present
 Member of the American and Michigan Academy of Nutrition and Dietetics, 2012-Present
 Member of Southeastern Michigan Dietetic Association 2012-Present
 President of the American University of Beirut Nutrition Students Society 2009-2011
 Volunteer at the St. Jude Children's Cancer Center of Lebanon 2009-2011
 Member of the Lebanese Red Cross Team 2008-2010